

Racores

Conectores neumáticos en diferentes materiales para las aplicaciones neumáticas:

- Metálicos (Bronce)
- Acero Inoxidable
- Plásticos (PBT)

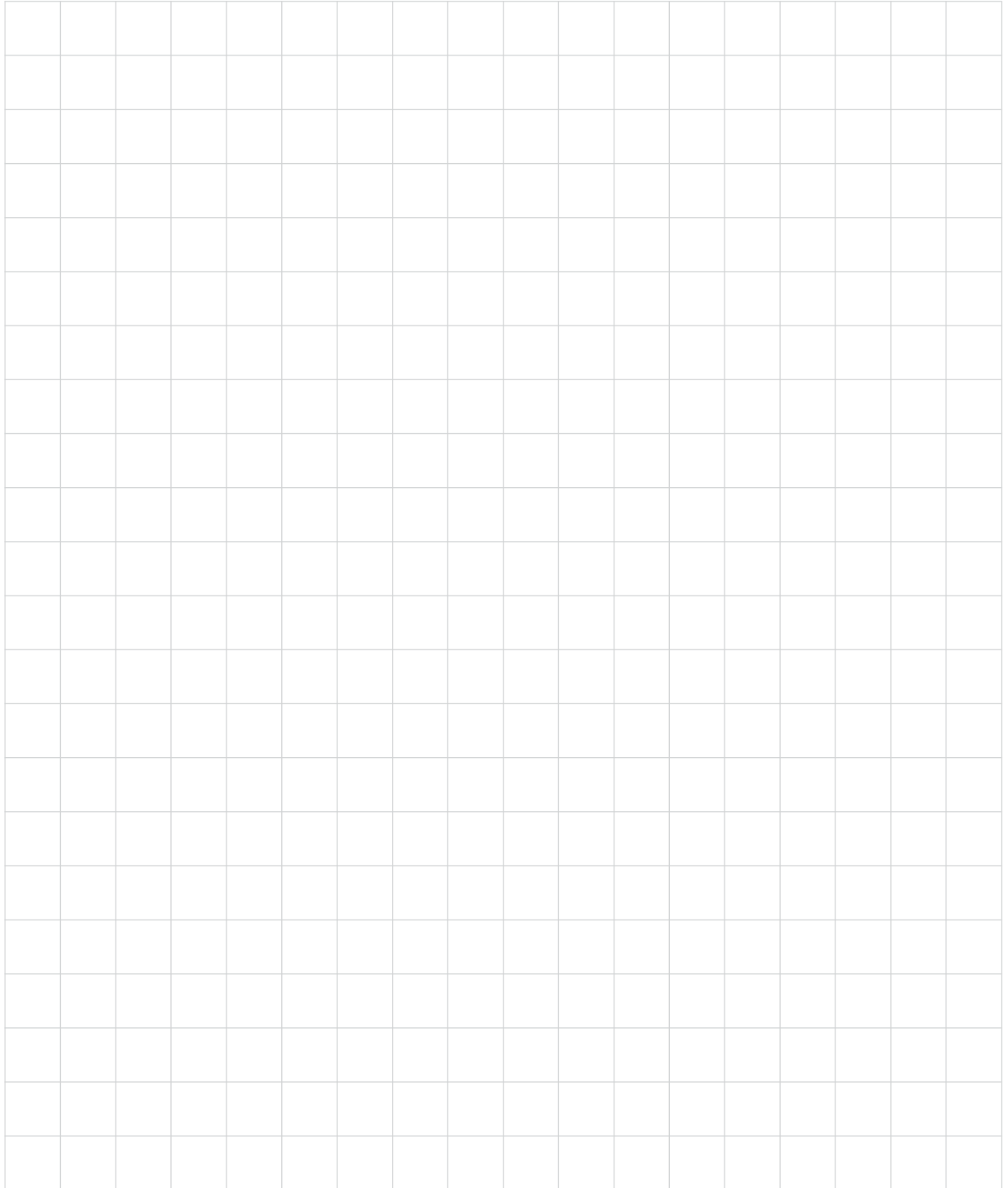



Controles De Flujo Montaje Directo	
Control De Flujo Metálico Serie RM (Milimétrico)	Racores-271
Control De Flujo Plástico Serie RP (En Pulgadas)	Racores-283
Control De Flujo Plástico Serie RP (Milimétrico)	Racores-288
Control De Flujo Con Cheque Incorporado	
Serie RPC (Milimétrico)	Racores-289
Control De Flujo Plástico Serie RP (Milimétrico PT)	Racores-295



Racores Metálicos	
Racores Metálicos En Pulgadas (Rosca NPT)	
Serie RM (10/32", 1/8", 1/4", 3/8", 1/2")	Racores-268
Racores Metálicos Milimétricos (Rosca G)	
Serie RM (M5, 1/8", 1/4", 3/8", 1/2")	Racores-272



Racores En Acero Inoxidable 316L	
Racores Inoxidables En Pulgadas (Rosca NPT)	
Serie RI (1/8", 1/4", 3/8", 1/2")	Racores-275
Racores Inoxidables Milimétricos (Rosca G)	
Serie RI (M5, 1/8", 1/4", 3/8", 1/2")	Racores-278



Racores Plásticos	
Racores Plásticos En Pulgadas (Rosca NPT)	
Serie RP (10/32", 1/8", 1/4", 3/8", 1/2")	Racores-282
Racores Plásticos Milimétricos (Rosca G)	
Serie RP (M5, 1/8", 1/4", 3/8", 1/2")	Racores-290
Racores Plásticos Milimétricos (Rosca PT)	
Serie RP (1/8", 1/4", 3/8", 1/2")	Racores-296



Racores Especiales	
Racores Plásticos Two-Touch (Rosca R)	
Serie RRP (1/8", 1/4", 3/8", 1/2")	Racores-297
Racores Con Detención - Tipo Acople Rápido	
Serie RD (1/8", 1/4", 3/8")	Racores-298

RACORES

RACORES METALICOS

SERIE RM - EN PULGADAS Y MILIMETRICOS

Art

Características

- Todas las roscas están fabricadas con junta de cierre que permiten un montaje rápido y sencillo de los circuitos neumáticos
- Excelente sujeción de las mangueras
- Racores rectos con hexágono interno que permite el montaje en espacios reducidos
- Seguros y resistentes a la corrosión

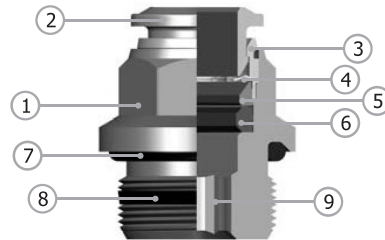

Materiales y Componentes

Item	Parte	Material
1	Cuerpo	Bronce Niquelado
2	Anillo Colector	Bronce Niquelado
3	Capsula	Bronce Niquelado
4	Anillo de Sujeción	Acero Inoxidable 304
5	Anillo de Seguridad	Tecnopolímero
6	Anillo de Labio	NBR
7	O-ring (Roscas G)	NBR
8	Empaque (Roscas NPT)	NBR
9	Hexágono Interno	

Datos Técnicos

Fluido:

Aire comprimido y vacío

Presión de Trabajo:

-1 a 15 Bar ~ -14,7 a 217 PSI

Temperatura de Trabajo:

-20°C a 80°C ~ -4°F a 176°F

Roscas:

Pulgadas - NPT

Milimétricos - G

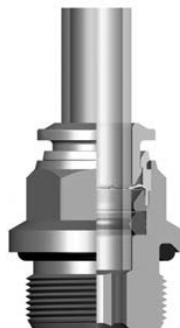

El anillo de sujeción en acero inoxidable asegura el perfecto agarre de la manguera sin dañar la superficie

La conexión entre la manguera y el racor aseguran el agarre en condiciones extremas de impacto y vibración.

La forma geométrica de la junta asegura la estanqueidad para uso con vacío.

RACORES METALICOS - EN PULGADAS

SERIE RM 10/32 - 1/8 - 1/4 - 3/8 - 1/2 NPT

Art



Racor Recto

Referencia	NPT	OD
RM102M502	10/32"	1/4"
RM1020101	1/8"	1/8"
RM1020102	1/8"	1/4"
RM1020202	1/4"	1/4"
RM1020209	1/4"	5/16"
RM1020203	1/4"	3/8"
RM1020302	3/8"	1/4"
RM1020303	3/8"	3/8"
RM1020304	3/8"	1/2"
RM1020403	1/2"	3/8"
RM1020404	1/2"	1/2"



Racor Codo - Giratorio

Referencia	NPT	OD
RM104M502	10/32"	1/4"
RM1040101	1/8"	1/8"
RM1040102	1/8"	1/4"
RM1040202	1/4"	1/4"
RM1040209	1/4"	5/16"
RM1040203	1/4"	3/8"
RM1040302	3/8"	1/4"
RM1040303	3/8"	3/8"
RM1040304	3/8"	1/2"
RM1040403	1/2"	3/8"
RM1040404	1/2"	1/2"



Racor Tee Vertical - Giratorio

Referencia	NPT	OD
RM1080102	1/8"	1/4"
RM1080202	1/4"	1/4"
RM1080303	3/8"	3/8"
RM1080404	1/2"	1/2"



Racor Tee Horizontal - Giratorio

Referencia	NPT	OD
RM1090202	1/4"	1/4"
RM1090209	1/4"	5/16"
RM1090404	1/2"	1/2"

RACORES

RACORES METALICOS - EN PULGADAS

SERIE RM 10/32 - 1/8 - 1/4 - 3/8 - 1/2 NPT

Art



Unión Recta

Referencia	OD
RM11102	1/4"
RM11109	5/16"
RM11103	3/8"
RM11104	1/2"



Unión Codo

Referencia	OD
RM11202	1/4"
RM11209	5/16"
RM11203	3/8"
RM11204	1/2"



Unión Tee

Referencia	OD
RM11302	1/4"
RM11309	5/16"
RM11303	3/8"
RM11304	1/2"



Unión Pasamuro

Referencia	OD
RM11602	1/4"
RM11109	5/16"
RM11603	3/8"



Reducción

Referencia	Conexión ID	OD
RM1200302	3/8	1/4"
RM1200309	3/8	5/16"
RM1200403	1/2	3/8"

CONTROLES DE FLUJO METALICOS - MILIMETRICOS

SERIE RM M5 - 1/8 - 1/4 - 3/8 - 1/2 ROSCA G

Art



Características

- Control de flujo unidireccional
- Excelente sujeción de las mangueras
- Montaje directo sobre los cilindros neumáticos facilitando el control
- Cuerpo orientable que facilita el montaje

Control de Flujo Metálico

Código / Referencia	Rosca G	OD
RM201M504	M5	4
RM201M506	M5	6
RM2010106	1/8"	6
RM2010108	1/8"	8
RM2010206	1/4"	6
RM2010208	1/4"	8
RM2010210	1/4"	10
RM2010308	3/8"	8
RM2010310	3/8"	10
RM2010412	1/2"	12

Datos Técnicos

Fluido:
Aire comprimido y vacío

Presión de Trabajo:
1 a 10 Bar ~ 14,7 a 147 PSI

Temperatura de Trabajo:
-20°C a 80°C ~ -4°F a 176°F

Roscas:
Milimétricas - G

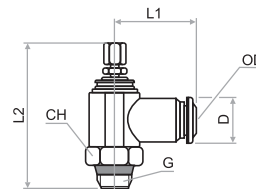

Referencia	G	OD	CH	D	L1	L2
RM201M504	M5	4	8	10	19	42,5
RM201M506	M5	6	8	12,5	20,5	42,5
RM2010106	1/8"	6	14	12,5	22,5	49
RM2010108	1/8"	8	14	14	24	49
RM2010206	1/4"	6	17	12,5	25	55
RM2010208	1/4"	8	17	14	26	55
RM2010210	1/4"	10	17	17	28,5	55
RM2010308	3/8"	8	20	14	28,5	65
RM2010310	3/8"	10	20	17	30,5	65
RM2010412	1/2"	12	24	21,5	35	69

Materiales

Cuerpo : Bronce Niquelado
Empaques : NBR

RACORES METALICOS - MILIMETRICOS

SERIE RM M5 - 1/8" - 1/4" - 3/8" - 1/2" ROSCA G

Art



Racor Recto

Referencia	G	OD
RM202M504	M5	4
RM202M506	M5	6
RM2020104	1/8"	4
RM2020106	1/8"	6
RM2020108	1/8"	8
RM2020204	1/4"	4
RM2020206	1/4"	6
RM2020208	1/4"	8
RM2020210	1/4"	10
RM2020308	3/8"	8
RM2020310	3/8"	10
RM2020312	3/8"	12
RM2020410	1/2"	10
RM2020412	1/2"	12



Racor Codo - Giratorio

Referencia	G	OD
RM204M504	M5	4
RM2040104	1/8"	4
RM2040106	1/8"	6
RM2040108	1/8"	8
RM2040204	1/4"	4
RM2040206	1/4"	6
RM2040208	1/4"	8
RM2040210	1/4"	10
RM2040308	3/8"	8
RM2040310	3/8"	10
RM2040312	3/8"	12
RM2040410	1/2"	10
RM2040412	1/2"	12



Racor Tee Vertical - Giratorio

Referencia	G	OD
RM2080106	1/8"	6
RM2080206	1/4"	6
RM2080208	1/4"	8



Racor Tee Horizontal - Giratorio

Referencia	G	OD
RM2090106	1/8"	6
RM2090206	1/4"	6
RM2090208	1/4"	8

RACORES METALICOS - MILIMETRICOS

SERIE RM M5 - 1/8 - 1/4 - 3/8 - 1/2 ROSCA G

Art



Unión Recta

Referencia	OD
RM21104	4
RM21106	6
RM21108	8
RM21110	10
RM21112	12



Unión Codo

Referencia	OD
RM21204	4
RM21206	6
RM21208	8
RM21210	10
RM21212	12



Unión Tee

Referencia	OD
RM21304	4
RM21306	6
RM21308	8
RM21310	10
RM21312	12



Unión Pasamuro

Referencia	OD
RM21606	6
RM21608	8
RM21610	10



Reducción

Referencia	Conexión ID	OD
RM2200604	6	4
RM2200806	8	6
RM2201008	10	8

RACORES

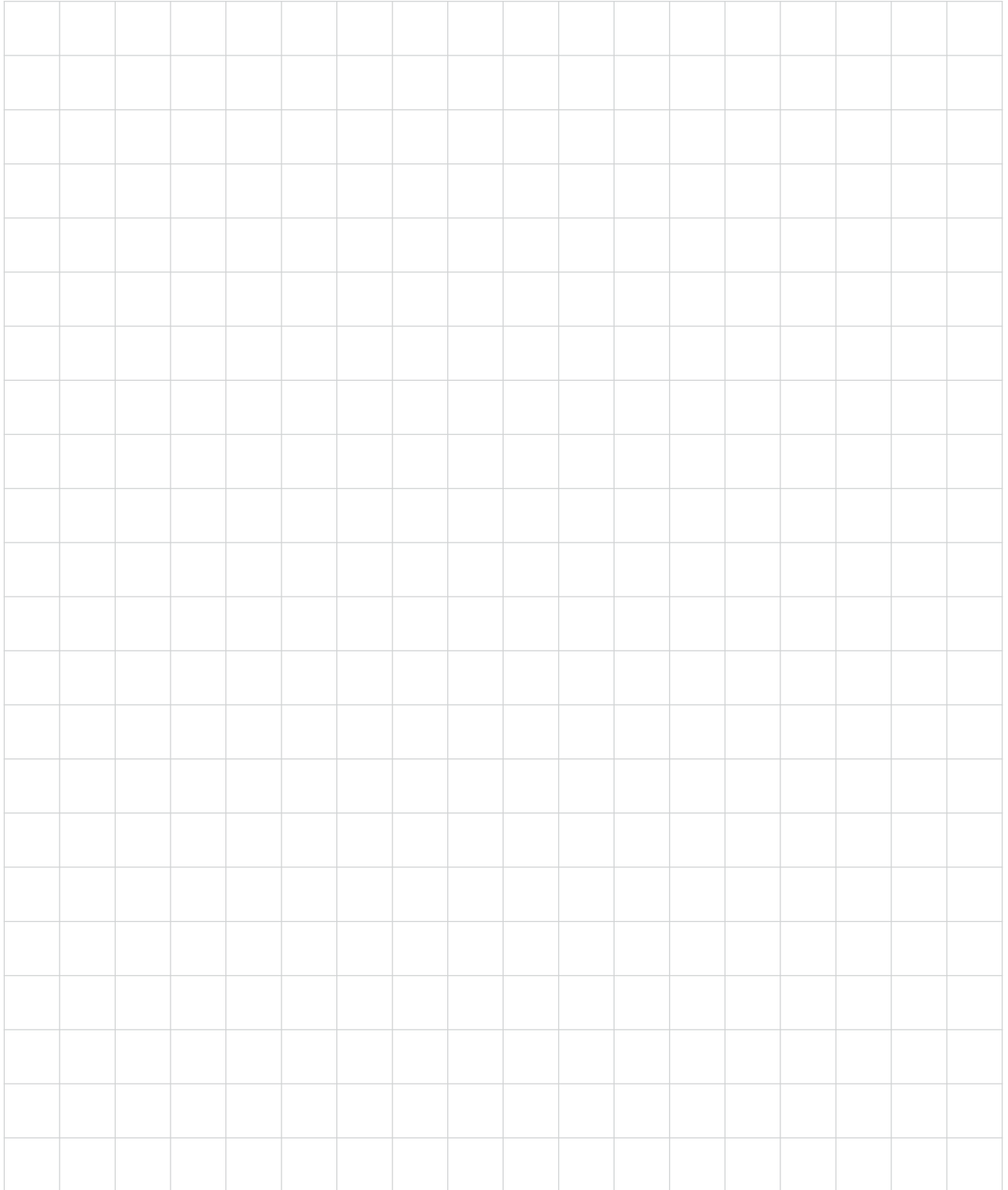

Características

- Todas las roscas están fabricadas con junta de cierre que permiten un montaje rápido y sencillo de los circuitos neumáticos
- Juntas en Vitón de uso alimenticio, Farmacéutico, Químico, Medicinal, entre otros
- Racores rectos con hexágono interno que permite el montaje en espacios reducidos
- Seguros y resistentes a la corrosión

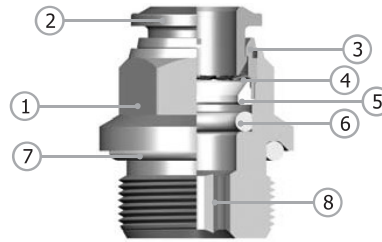

Materiales y Componentes

Item	Parte	Material
1	Cuerpo	Acero Inox. Aisi 316L
2	Anillo Colector	Acero Inox. Aisi 316L
3	Capsula	Acero Inox. Aisi 316L
4	Anillo de Sujeción	Acero Inox. Aisi 316L
5	Anillo de Seguridad	PTFE
6	Anillo de Labio (Uso Alimenticio)	FKM
7	O-ring (Uso Alimenticio)	FKM
8	Hexágono Interno	

Datos Técnicos

Fluido:

Aire comprimido y vacío
 Fluidos para industria alimenticia y química compatibles con los componentes del racor

Presión de Trabajo:

-1 a 15 Bar ~ -14,7 a 217 PSI

Temperatura de Trabajo:

-15°C a 225°C ~ 5°F a 437°F

Roscas:

Pulgadas - NPT
 Milimétricos - G

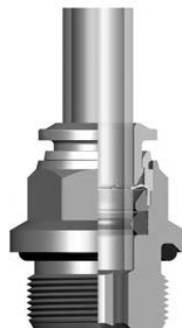

El anillo de sujeción en acero inoxidable asegura el perfecto agarre de la manguera sin dañar la superficie

La conexión entre la manguera y el racor aseguran el agarre en condiciones extremas de impacto y vibración.

La forma geométrica de la junta asegura la estanqueidad para uso con vacío.

RACORES EN ACERO INOXIDABLE 316L - EN PULGADAS

SERIE RI 1/8 - 1/4 - 3/8 - 1/2 NPT

Art



Racor Recto - Inox. 316L

Referencia	NPT	OD
RI1020102	1/8"	1/4"
RI1020202	1/4"	1/4"
RI1020209	1/4"	5/16"
RI1020203	1/4"	3/8"
RI1020303	3/8"	3/8"
RI1020304	3/8"	1/2"
RI1020404	1/2"	1/2"



Racor Codo - Giratorio - Inox. 316L

Referencia	NPT	OD
RI1040102	1/8"	1/4"
RI1040202	1/4"	1/4"
RI1040209	1/4"	5/16"
RI1040203	1/4"	3/8"
RI1040303	3/8"	3/8"
RI1040304	3/8"	1/2"
RI1040404	1/2"	1/2"



Racor Tee Horizontal - Giratorio - Inox. 316L

Referencia	NPT	OD
RI1090102	1/8"	1/4"
RI1090202	1/4"	1/4"
RI1090209	1/4"	5/16"
RI1090303	3/8"	3/8"
RI1090404	1/2"	1/2"

RACORES EN ACERO INOXIDABLE 316L - EN PULGADAS

SERIE RI 1/8 - 1/4 - 3/8 - 1/2 NPT

Art



Unión Recta - Inox. 316L

Referencia	OD
RI11102	1/4"
RI11109	5/16"
RI11103	3/8"
RI11104	1/2"



Unión Codo - Inox. 316L

Referencia	OD
RI11202	1/4"
RI11209	5/16"
RI11203	3/8"
RI11204	1/2"



Unión Tee - Inox. 316L

Referencia	OD
RI11302	1/4"
RI11309	5/16"
RI11303	3/8"
RI11304	1/2"



Unión Pasamuro - Inox. 316L

Referencia	OD
RI11602	1/4"
RI11609	5/16"
RI11603	3/8"

RACORES

RACORES EN ACERO INOXIDABLE 316L - MILIMETRICOS

SERIE RI M5 - 1/8" - 1/4" - 3/8" - 1/2" ROSCA G

Art



Racor Recto - Inox. 316L

Referencia	G	OD
RI202M505	M5	4
RI2020104	1/8"	4
RI2020106	1/8"	6
RI2020108	1/8"	8
RI2020204	1/4"	4
RI2020206	1/4"	6
RI2020208	1/4"	8
RI2020210	1/4"	10
RI2020310	3/8"	10
RI2020312	3/8"	12
RI2020412	1/2"	12



Racor Codo - Giratorio - Inox. 316L

Referencia	G	OD
RI204M505	M5	4
RI2040104	1/8"	4
RI2040106	1/8"	6
RI2040108	1/8"	8
RI2040204	1/4"	4
RI2040206	1/4"	6
RI2040208	1/4"	8
RI2040210	1/4"	10
RI2040310	3/8"	10
RI2040312	3/8"	12
RI2040412	1/2"	12



Racor Tee Horizontal - Giratorio - Inox. 316L

Referencia	G	OD
RI2090106	1/8"	6
RI2090206	1/4"	6
RI2090208	1/4"	8

RACORES EN ACERO INOXIDABLE 316L - MILIMETRICOS

SERIE RI M5 - 1/8 - 1/4 - 3/8 - 1/2 ROSCA G

Art



Unión Recta - Inox. 316L

Referencia	OD
RI21104	4
RI21106	6
RI21108	8
RI21110	10
RI21112	12



Unión Codo - Inox. 316L

Referencia	OD
RI21204	4
RI21206	6
RI21208	8
RI21210	10
RI21212	12



Unión Tee - Inox. 316L

Referencia	OD
RI21304	4
RI21306	6
RI21308	8
RI21310	10
RI21312	12



Unión Pasamuro - Inox. 316L

Referencia	OD
RI21606	6
RI21608	8
RI21610	10

RACORES

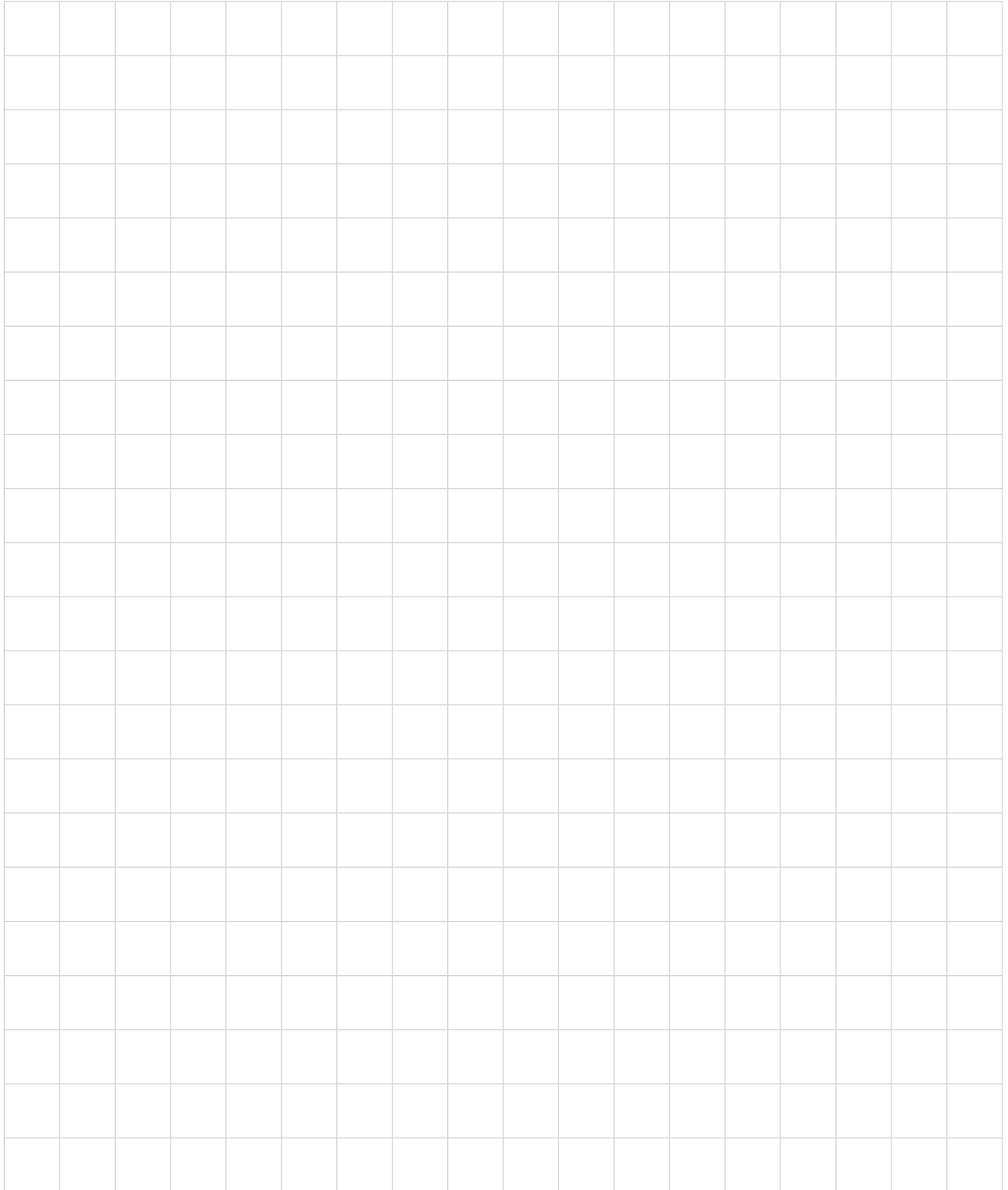

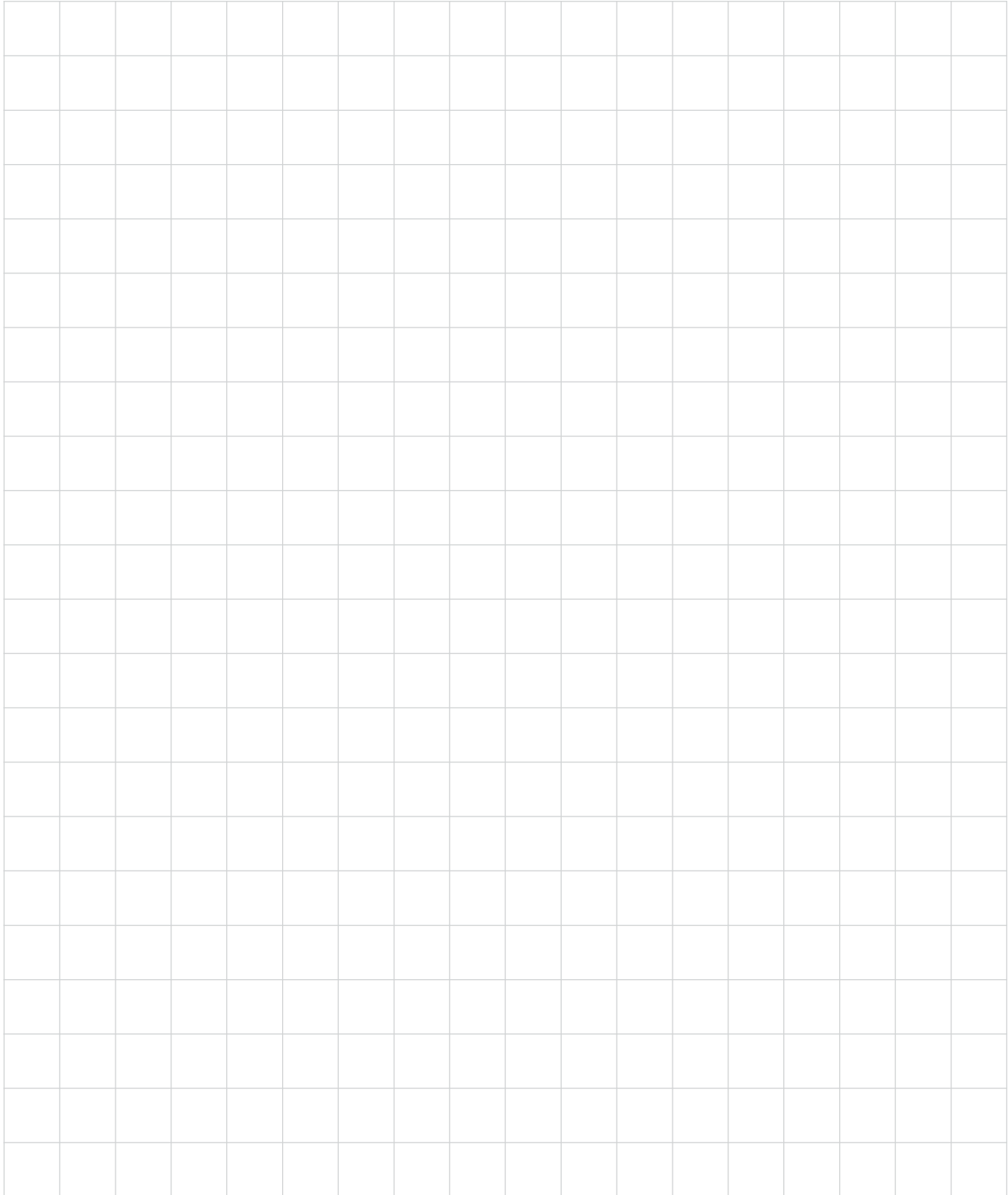

RACORES PLASTICOS

SERIE RP - EN PULGADAS Y MILIMETRICOS

Art

Características

- Permiten un montaje rápido y sencillo de los circuitos neumáticos
- Excelente sujeción de las mangueras
- Racores rectos con hexágono interno que permite el montaje en espacios reducidos
- Satisfacen las características de anti-contaminación

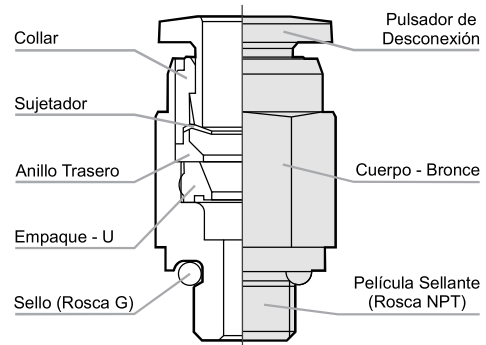

Datos Técnicos

Fluido:
Aire comprimido y vacío

Presión de Trabajo:
-1 a 10 Bar ~ -14,7 a 150 PSI

Temperatura de Trabajo:
0°C a 60°C ~ 32°F a 140°F

Roscas:
Pulgadas - NPT
Milimétricos - G

Materiales

Cuerpo : PBT
(Politereftalato de Butileno)

Roscas : Bronce Niquelado

Empaques : NBR

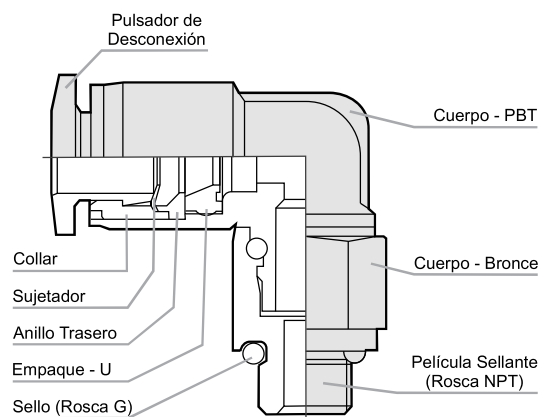

CONTROLES DE FLUJO PLASTICOS - EN PULGADAS

SERIE RP 1/8 - 1/4 - 3/8 - 1/2 NPT

Art



Características

- Permiten controlar una velocidad constante del cilindro fácilmente
- Con un sistema de bloqueo para evitar manipulaciones no deseadas
- Fácil instalación al fijarlos directamente a las conexiones del cilindro
- Regulación de la velocidad en un solo sentido



Control de Flujo en Pulgadas

Código	NPT	OD	Flujo l/min.
RP1010102	1/8"	1/4"	350
RP1010202	1/4"	1/4"	600
RP1010203	1/4"	3/8"	640
RP1010302	3/8"	1/4"	1.100
RP1010303	3/8"	3/8"	1.100
RP1010304	3/8"	1/2"	1.100
RP1010403	1/2"	3/8"	1.100
RP1010404	1/2"	1/2"	1.700

Datos Técnicos

Fluido:

Aire comprimido

Presión de Trabajo:

-1 a 10 Bar ~ -14,7 a 150 PSI

Temperatura de Trabajo:

0°C a 60°C ~ 32°F a 140°F

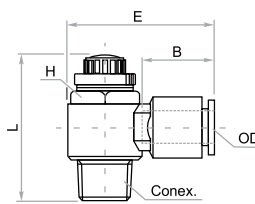

Materiales

Cuerpo : PBT
 Perilla : Bronce Niquelado
 Empaques : NBR

Referencia	NPT	OD	B	E	L Max.	H Hex.
RP1010102	1/8"	1/4"	17,4	32,0	40,1	7/16
RP1010202	1/4"	1/4"	17,4	35,9	45,7	19/32
RP1010203	1/4"	3/8"	20,2	37,5	45,7	19/32
RP1010302	3/8"	1/4"	17,4	39,7	55,0	3/4
RP1010303	3/8"	3/8"	20,2	42,1	55,0	3/4
RP1010304	3/8"	1/2"	22,0	45,1	55,0	3/4
RP1010403	1/2"	3/8"	20,2	47,3	60,2	15/16
RP1010404	1/2"	1/2"	22,0	50,5	60,2	15/16

RACORES

Art

Racores-283

RACORES PLASTICOS - EN PULGADAS

SERIE RP 10/32 - 1/8 - 1/4 - 3/8 - 1/2 NPT

Art



Racor Recto

Referencia	NPT	OD
RP102M502	10/32"	1/4"
RP1020101	1/8"	1/8"
RP1020102	1/8"	1/4"
RP1020103	1/8"	3/8"
RP1020109	1/8"	5/16"
RP1020202	1/4"	1/4"
RP1020209	1/4"	5/16"
RP1020203	1/4"	3/8"
RP1020204	1/4"	1/2"
RP1020302	3/8"	1/4"
RP1020309	3/8"	5/16"
RP1020303	3/8"	3/8"
RP1020304	3/8"	1/2"
RP1020402	1/2"	1/4"
RP1020409	1/2"	5/16"
RP1020403	1/2"	3/8"
RP1020404	1/2"	1/2"



Racor Codo - Giratorio

Referencia	NPT	OD
RP104M502	10/32"	1/4"
RP1040101	1/8"	1/8"
RP1040102	1/8"	1/4"
RP1040103	1/8"	3/8"
RP1040109	1/8"	5/16"
RP1040202	1/4"	1/4"
RP1040209	1/4"	5/16"
RP1040203	1/4"	3/8"
RP1040204	1/4"	1/2"
RP1040302	3/8"	1/4"
RP1040309	3/8"	5/16"
RP1040303	3/8"	3/8"
RP1040304	3/8"	1/2"
RP1040402	1/2"	1/4"
RP1040409	1/2"	5/16"
RP1040403	1/2"	3/8"
RP1040404	1/2"	1/2"



Racor Recto Hembra

Referencia	NPT	OD
RP1030102	1/8"	1/4"
RP1030109	1/8"	5/16"
RP1030202	1/4"	1/4"
RP1030209	1/4"	5/16"
RP1030203	1/4"	3/8"



Racor Codo Hembra

Referencia	NPT	OD
RP1050102	1/8"	1/4"
RP1050109	1/8"	5/16"
RP1050202	1/4"	1/4"
RP1050209	1/4"	5/16"
RP1050203	1/4"	3/8"

RACORES PLASTICOS - EN PULGADAS

SERIE RP 10/32 - 1/8 - 1/4 - 3/8 - 1/2 NPT

Art



Racor Codo Extendido

Referencia	NPT	OD
RP1060102	1/8"	1/4"
RP1060202	1/4"	1/4"
RP1060209	1/4"	5/16"
RP1060203	1/4"	3/8"
RP1060303	3/8"	3/8"



Racor Codo Banjo

Referencia	NPT	OD
RP1070102	1/8"	1/4"
RP1070202	1/4"	1/4"
RP1070209	1/4"	5/16"
RP1070203	1/4"	3/8"
RP1070303	3/8"	3/8"



Racor Tee Horizontal - Giratorio

Referencia	NPT	OD
RP1090102	1/8"	1/4"
RP1090202	1/4"	1/4"
RP1090209	1/4"	5/16"
RP1090203	1/4"	3/8"
RP1090302	3/8"	1/4"
RP1090303	3/8"	3/8"
RP1090304	3/8"	1/2"
RP1090403	1/2"	3/8"
RP1090404	1/2"	1/2"



Racor Yee - Giratorio

Referencia	NPT	OD
RP1100102	1/8"	1/4"
RP1100202	1/4"	1/4"
RP1100209	1/4"	5/16"
RP1100303	3/8"	3/8"



Unión Recta

Referencia	OD
RP11102	1/4"
RP11109	5/16"
RP11103	3/8"
RP11104	1/2"



Unión Codo

Referencia	OD
RP11202	1/4"
RP11209	5/16"
RP11203	3/8"
RP11204	1/2"

RACORES

RACORES PLASTICOS - EN PULGADAS

SERIE RP 10/32 - 1/8 - 1/4 - 3/8 - 1/2 NPT

Art



Unión Tee

Referencia	OD
RP11302	1/4"
RP11309	5/16"
RP11303	3/8"
RP11304	1/2"



Unión Yee

Referencia	OD
RP11402	1/4"
RP11409	5/16"
RP11403	3/8"
RP11404	1/2"



Unión Cruz

Referencia	OD
RP11502	1/4"
RP11509	5/16"
RP11503	3/8"
RP11504	1/2"



Unión Pasamuro

Referencia	OD	T
RP11602	1/4"	M14x1.0
RP11609	5/16"	M16x1.0
RP11603	3/8"	M20x1.0
RP11604	1/2"	M22x1.0



Unión Codo Pasamuro

Referencia	OD	T
RP11702	1/4"	M14x1.0
RP11709	5/16"	M16x1.0
RP11703	3/8"	M20x1.0



Acople Pitorra

Referencia	OD
RP11802	1/4"
RP11809	5/16"
RP11803	3/8"
RP11804	1/2"

RACORES PLASTICOS - EN PULGADAS

SERIE RP 10/32 - 1/8 - 1/4 - 3/8 - 1/2 NPT

Art



Reducción Manguera

Referencia	OD 1	OD 2
RP1190902	5/16"	1/4"
RP1190302	3/8"	1/4"
RP1190309	3/8"	5/16"
RP1190403	1/2"	3/8"



Reducción P/Racor

Referencia	ID	OD 2
RP1200902	5/16"	1/4"
RP1200302	3/8"	1/4"
RP1200309	3/8"	5/16"
RP1200402	1/2"	1/4"
RP1200403	1/2"	3/8"



Tapón P/Racor

Referencia	OD
RP12102	1/4"
RP12109	5/16"
RP12103	3/8"



Tapón P/Manguera

Referencia	OD
RP12202	1/4"
RP12209	5/16"
RP12203	3/8"
RP12204	1/2"



Manifold - 4 Salidas

Referencia	NPT	OD 1	OD 2
RP1230209	1/4"	5/16"	1/4"
RP1230303	3/8"	3/8"	5/16"

RACORES

Art

Racores-287

CONTROLES DE FLUJO PLASTICOS - MILIMETRICOS

SERIE RP M5 - 1/8 - 1/4 - 3/8 - 1/2 Rosca G

Ar.t



Características

- Permiten controlar una velocidad constante del cilindro fácilmente
- Con un sistema de bloqueo para evitar manipulaciones no deseadas
- Fácil instalación al fijarlos directamente a las conexiones del cilindro
- Regulación de la velocidad en un solo sentido

Control de Flujo Milimetrico

Código	NPT	OD	Flujo l/min.
RP201M504	M5	4	100
RP201M506	M5	6	100
RP2010106	1/8"	6	350
RP2010108	1/8"	8	350
RP2010206	1/4"	6	600
RP2010208	1/4"	8	640
RP2010210	1/4"	10	640
RP2010306	3/8"	6	1.100
RP2010308	3/8"	8	1.100
RP2010310	3/8"	10	1.100
RP2010312	3/8"	12	1.100
RP2010410	1/2"	10	1.700
RP2010412	1/2"	12	1.700

Datos Técnicos

Fluido:
Aire comprimido

Presión de Trabajo:
-1 a 10 Bar ~ -14,7 a 150 PSI

Temperatura de Trabajo:
0°C a 60°C ~ 32°F a 140°F

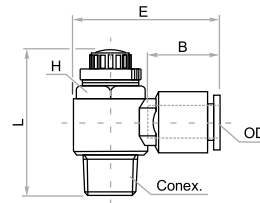

Materiales

Cuerpo : PBT
Perilla : Bronce Niquelado
Empaques : NBR

Referencia	NPT	OD	B	E	L Max.	H Hex.
RP201M504	M5	4	16.3	25.1	30.2	8
RP201M506	M5	6	17.6	27.8	30.2	8
RP2010106	1/8"	6	17.6	31.2	40.1	8
RP2010108	1/8"	8	18.7	33	40.1	8
RP2010206	1/4"	6	17.6	35	45.7	12
RP2010208	1/4"	8	18.7	36.8	45.7	12
RP2010210	1/4"	10	19.6	38.8	45.7	12
RP2010306	3/8"	6	17.6	38.7	55	14
RP2010308	3/8"	8	18.7	40.1	55	14
RP2010310	3/8"	10	19.6	42.2	55	14
RP2010312	3/8"	12	21.9	45.9	55	14
RP2010410	1/2"	10	19.6	47.5	60.2	19
RP2010412	1/2"	12	21.9	50.1	60.2	19

CONTROLES DE FLUJO CON CHEQUE - MILIMÉTRICOS

SERIE RPC 1/8 - 1/4 - 3/8 Rosca G

Art



Características

- Garantizan la parada intermedia de un cilindro al bloquear la salida del aire
- Permiten controlar una velocidad constante del cilindro fácilmente
- Con un sistema de bloqueo para evitar manipulaciones no deseadas
- Fácil instalación al fijarlos directamente a las conexiones del cilindro
- Regulación de la velocidad en un solo sentido

Milimétricos

Referencia	G	OD
RPC10106	1/8"	6
RPC10206	1/4"	6
RPC10208	1/4"	8
RPC10308	3/8"	8
RPC10310	3/8"	10

Datos Técnicos

Fluido:
Aire comprimido

Presión de Trabajo:
-1 a 10 Bar ~ -14,7 a 150 PSI

Temperatura de Trabajo:
0°C a 60°C ~ 32°F a 140°F

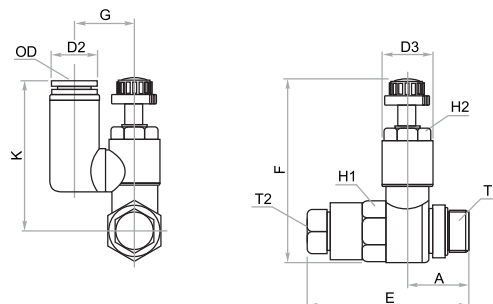

Referencia	OD	A	D2	D3	E	F
RPC10106	6	16,0	12,6	12,1	35,4	48,4
RPC10206	6	18,1	12,6	15,4	42,0	60,4
RPC10208	8	18,1	14,9	15,4	42,0	60,4
RPC10308	8	21,0	15,1	20,3	49,7	63,4
RPC10310	10	21,0	17,6	20,3	49,7	63,4

Referencia	G	H1	H2	K	T1	T2
RPC10106	16,1	12	10	38,9	G 1/8	M5
RPC10206	19,4	17	13	44,3	G 1/4	G 1/8
RPC10208	18,4	17	13	46,7	G 1/4	G 1/8
RPC10308	23,4	19	17	50,7	G 3/8	G 1/8
RPC10310	23,4	19	17	53,0	G 3/8	G 1/8

Materiales

Cuerpo : PBT
Perilla : Bronce Niquelado
Empaques : NBR

RACORES

Art

Racores-289

RACORES PLASTICOS - MILIMETRICOS

SERIE RP M5 - 1/8 - 1/4 - 3/8 - 1/2 Rosca G

Art



Racor Recto

Referencia	G	OD
RP202M504	M5	4
RP202M506	M5	6
RP2020104	1/8"	4
RP2020106	1/8"	6
RP2020108	1/8"	8
RP2020110	1/8"	10
RP2020204	1/4"	4
RP2020206	1/4"	6
RP2020208	1/4"	8
RP2020210	1/4"	10
RP2020212	1/4"	12
RP2020306	3/8"	6
RP2020308	3/8"	8
RP2020310	3/8"	10
RP2020312	3/8"	12
RP2020406	1/2"	6
RP2020408	1/2"	8
RP2020410	1/2"	10
RP2020412	1/2"	12
RP2020416	1/2"	16



Racor Codo - Giratorio

Referencia	G	OD
RP204M504	M5	4
RP204M506	M5	6
RP2040104	1/8"	4
RP2040106	1/8"	6
RP2040108	1/8"	8
RP2040110	1/8"	10
RP2040204	1/4"	4
RP2040206	1/4"	6
RP2040208	1/4"	8
RP2040210	1/4"	10
RP2040212	1/4"	12
RP2040306	3/8"	6
RP2040308	3/8"	8
RP2040310	3/8"	10
RP2040312	3/8"	12
RP2040406	1/2"	6
RP2040408	1/2"	8
RP2040410	1/2"	10
RP2040412	1/2"	12
RP2040416	1/2"	16



Racor Recto Hembra

Referencia	G	OD
RP2030106	1/8"	6
RP2030108	1/8"	8
RP2030206	1/4"	6
RP2030208	1/4"	8



Racor Codo Hembra

Referencia	G	OD
RP2050106	1/8"	6
RP2050108	1/8"	8
RP2050206	1/4"	6
RP2050208	1/4"	8

RACORES PLASTICOS - MILIMETRICOS

SERIE RP M5 - 1/8 - 1/4 - 3/8 - 1/2 Rosca G

Art



Racor Codo Extendido

Referencia	G	OD
RP2060104	1/8"	4
RP2060106	1/8"	6
RP2060108	1/8"	8
RP2060206	1/4"	6
RP2060208	1/4"	8
RP2060210	1/4"	10
RP2060308	3/8"	8



Racor Codo Banjo

Referencia	G	OD
RP2070104	1/8"	4
RP2070106	1/8"	6
RP2070108	1/8"	8
RP2070206	1/4"	6
RP2070208	1/4"	8
RP2070210	1/4"	10



Racor Tee Horizontal - Giratorio

Referencia	G	OD
RP209M504	M5	4
RP209M506	M5	6
RP2090104	1/8"	4
RP2090106	1/8"	6
RP2090108	1/8"	8
RP2090204	1/4"	4
RP2090206	1/4"	6
RP2090208	1/4"	8
RP2090210	1/4"	10
RP2090306	3/8"	6
RP2090308	3/8"	8
RP2090310	3/8"	10
RP2090312	3/8"	12
RP2090410	1/2"	10
RP2090412	1/2"	12
RP2090416	1/2"	16



Racor Yee - Giratorio

Referencia	G	OD
RP2100106	1/8"	6
RP2100206	1/4"	6
RP2100208	1/4"	8
RP2100310	3/8"	10

RACORES

RACORES PLASTICOS - MILIMETRICOS

SERIE RP M5 - 1/8 - 1/4 - 3/8 - 1/2 Rosca G

Art



Unión Recta

Referencia	OD
RP21104	4
RP21106	6
RP21108	8
RP21110	10
RP21112	12
RP21116	16



Unión Codo

Referencia	OD
RP21204	4
RP21206	6
RP21208	8
RP21210	10
RP21212	12
RP21216	16



Unión Tee

Referencia	OD
RP21304	4
RP21306	6
RP21308	8
RP21310	10
RP21312	12



Unión Yee

Referencia	OD
RP21404	4
RP21406	6
RP21408	8
RP21410	10
RP21412	12



Unión Cruz

Referencia	OD
RP21504	4
RP21506	6
RP21508	8
RP21510	10



Unión Pasamuro

Referencia	OD	T
RP21604	4	M12x1.0
RP21606	6	M14x1.0
RP21608	8	M16x1.0
RP21610	10	M20x1.0
RP21612	12	M22x1.0

RACORES PLASTICOS - MILIMETRICOS

SERIE RP M5 - 1/8 - 1/4 - 3/8 - 1/2 Rosca G

Art



Unión Codo Pasamuro

Referencia	OD	T
RP21704	4	M12x1.0
RP21706	6	M14x1.0
RP21708	8	M16x1.0



Acople Pitorra

Referencia	OD
RP21806	6
RP21808	8
RP21810	10
RP21812	12



Reducción Manguera

Referencia	OD 1	OD 2
RP2190604	6	4
RP2190806	8	6
RP2191006	10	6
RP2191008	10	8
RP2191208	12	8
RP2191210	12	10



Reducción

Referencia	ID	OD
RP2200604	6	4
RP2200806	8	6
RP2201006	10	6
RP2201008	10	8
RP2201206	12	6
RP2201208	12	8
RP2201210	12	10



Tapón Racor

Referencia	OD
RP22104	4
RP22106	6
RP22108	8
RP22110	10
RP22112	12



Tapón Manguera

Referencia	OD
RP22204	4
RP22206	6
RP22208	8
RP22210	10
RP22212	12

RACORES

RACORES PLASTICOS - MILIMETRICOS

SERIE RP M5 - 1/8 - 1/4 - 3/8 - 1/2 Rosca G

Art

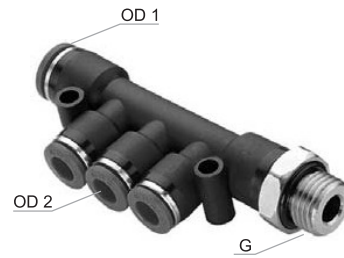

Manifold - 4 Salidas

Referencia	G	OD 1	OD 2
RP2230208	1/4"	8	6
RP2230310	3/8"	10	8



Manifold - 6 Salidas

Referencia	G	OD
RP2240206	1/4"	6
RP2240308	3/8"	8
RP2240310	3/8"	10

CONTROLES DE FLUJO PLASTICOS - MILIMETRICOS

SERIE RP 1/8 - 1/4 - 3/8 - 1/2 Rosca PT (R)

Art



Estos controles son especiales para instalar en roscas NPT para usar mangueras milimétricas



Características

- Permiten controlar una velocidad constante del cilindro fácilmente
- Con un sistema de bloqueo para evitar manipulaciones no deseadas
- Fácil instalación al fijarlos directamente a las conexiones del cilindro
- Regulación de la velocidad en un solo sentido

Control de Flujo Milimetrico

Código	PT (R)	OD	Flujo l/min.
RP3010106	1/8"	6	350
RP3010108	1/8"	8	350
RP3010206	1/4"	6	600
RP3010208	1/4"	8	640
RP3010210	1/4"	10	640
RP3010306	3/8"	6	1.100
RP3010308	3/8"	8	1.100
RP3010310	3/8"	10	1.100
RP3010312	3/8"	12	1.100
RP3010410	1/2"	10	1.700
RP3010412	1/2"	12	1.700

Datos Técnicos

Fluido:
Aire comprimido

Presión de Trabajo:
-1 a 10 Bar ~ -14,7 a 150 PSI

Temperatura de Trabajo:
0°C a 60°C ~ 32°F a 140°F

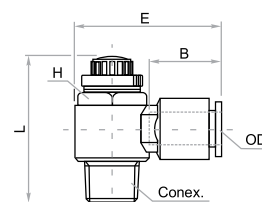

Materiales

Cuerpo : PBT
Perilla : Bronce Niquelado
Empaques : NBR

Referencia	PT (R)	OD	B	E	L Max.	H Hex.
RP3010106	1/8"	6	17.6	31.2	40.1	11
RP3010108	1/8"	8	18.7	33	40.1	11
RP3010206	1/4"	6	17.6	35	45.7	15
RP3010208	1/4"	8	18.7	36.8	45.7	15
RP3010210	1/4"	10	19.6	38.8	45.7	15
RP3010306	3/8"	6	17.6	38.7	55	19
RP3010308	3/8"	8	18.7	40.1	55	19
RP3010310	3/8"	10	19.6	42.2	55	19
RP3010312	3/8"	12	21.9	45.9	55	19
RP3010410	1/2"	10	19.6	47.5	60.2	24
RP3010412	1/2"	12	21.9	50.1	60.2	24

RACORES

RACORES PLASTICOS - MILIMETRICOS

SERIE RP 1/8 - 1/4 - 3/8 - 1/2 Rosca PT (R); Especiales para instalar en roscas NPT para usar mangueras milimétricas

Art



Racor Recto

Referencia	PT (R)	OD
RP3020104	1/8"	4
RP3020106	1/8"	6
RP3020108	1/8"	8
RP3020110	1/8"	10
RP3020204	1/4"	4
RP3020206	1/4"	6
RP3020208	1/4"	8
RP3020210	1/4"	10
RP3020212	1/4"	12
RP3020306	3/8"	6
RP3020308	3/8"	8
RP3020310	3/8"	10
RP3020312	3/8"	12
RP3020406	1/2"	6
RP3020408	1/2"	8
RP3020410	1/2"	10
RP3020412	1/2"	12
RP3020416	1/2"	16



Racor Codo - Giratorio

Referencia	PT (R)	OD
RP3040104	1/8"	4
RP3040106	1/8"	6
RP3040108	1/8"	8
RP3040110	1/8"	10
RP3040112	1/8"	12
RP3040204	1/4"	4
RP3040206	1/4"	6
RP3040208	1/4"	8
RP3040210	1/4"	10
RP3040212	1/4"	12
RP3040306	3/8"	6
RP3040308	3/8"	8
RP3040310	3/8"	10
RP3040312	3/8"	12
RP3040406	1/2"	6
RP3040408	1/2"	8
RP3040410	1/2"	10
RP3040412	1/2"	12
RP3040416	1/2"	16



Racor Tee Horizontal - Giratorio

Referencia	PT (R)	OD
RP3090104	1/8"	4
RP3090106	1/8"	6
RP3090108	1/8"	8
RP3090204	1/4"	4
RP3090206	1/4"	6
RP3090208	1/4"	8
RP3090210	1/4"	10
RP3090306	3/8"	6
RP3090308	3/8"	8
RP3090310	3/8"	10
RP3090312	3/8"	12
RP3090410	1/2"	10
RP3090412	1/2"	12
RP3090416	1/2"	16



Racor Yee - Giratorio

Referencia	PT (R)	OD
RP3100106	1/8"	6
RP3100206	1/4"	6
RP3100208	1/4"	8
RP3100310	3/8"	10

Características

- El mecanismo de la tuerca de fijación proporciona una conexión neumática semipermanente
- Resistente a la vibración y a los movimientos multi-direccionales de la tubería
- Buena tolerancia a la contaminación, la corrosión y químicos
- Composición plástica no magnética



Racor Recto - Azul

Referencia	R	OD
RRP2020106	1/8"	6
RRP2020108	1/8"	8
RRP2020206	1/4"	6
RRP2020208	1/4"	8
RRP2020210	1/4"	10
RRP2020212	1/4"	12
RRP2020308	3/8"	8
RRP2020310	3/8"	10
RRP2020312	3/8"	12
RRP2020412	1/2"	12



Racor Codo - Azul

Referencia	R	OD
RRP2040106	1/8"	6
RRP2040108	1/8"	8
RRP2040206	1/4"	6
RRP2040208	1/4"	8
RRP2040210	1/4"	10
RRP2040212	1/4"	12
RRP2040308	3/8"	8
RRP2040310	3/8"	10
RRP2040312	3/8"	12
RRP2040412	1/2"	12

Datos Técnicos

Fluido:
Aire comprimido y vacío

Presión de Trabajo:
-1 a 10 Bar ~ -14,7 a 150 PSI

Temperatura de Trabajo:
0°C a 60°C ~ 32°F a 140°F



Unión Tee - Azul

Referencia	OD
RRP21306	6
RRP21308	8
RRP21310	10
RRP21312	12



Características

- El aire es completamente bloqueado al retirar la manguera
- Excelente sujeción de las mangueras
- Ideal para puntos donde se requiere la conexión y desconexión frecuentes
- Satisfacen las características de anti-contaminación



En Pulgadas

Referencia	NPT	OD
RD1020102	1/8"	1/4"
RD1020202	1/4"	1/4"
RD1020209	1/4"	5/16"
RD1020303	3/8"	3/8"

Datos Técnicos

Fluido:
Aire comprimido

Presión de Trabajo:
-1 a 10 Bar ~ -14,7 a 150 PSI

Temperatura de Trabajo:
0°C a 60°C ~ 32°F a 140°F

Roscas:
Pulgadas - NPT
Milimétricos - G



Milimétricos

Referencia	G	OD
RD2020106	1/8"	6
RD2020206	1/4"	6
RD2020208	1/4"	8

Materiales

Cuerpo : Bronce Niquelado

Empaques : NBR