

Válvulas Direccionales

Nuestra línea de válvulas comprende:

- Válvulas 3/2, 4/2, 4/3, 5/2 y 5/3 vías

Con operadores:

- Solenoides
- Neumáticos
- Manuales
- Mecánicos

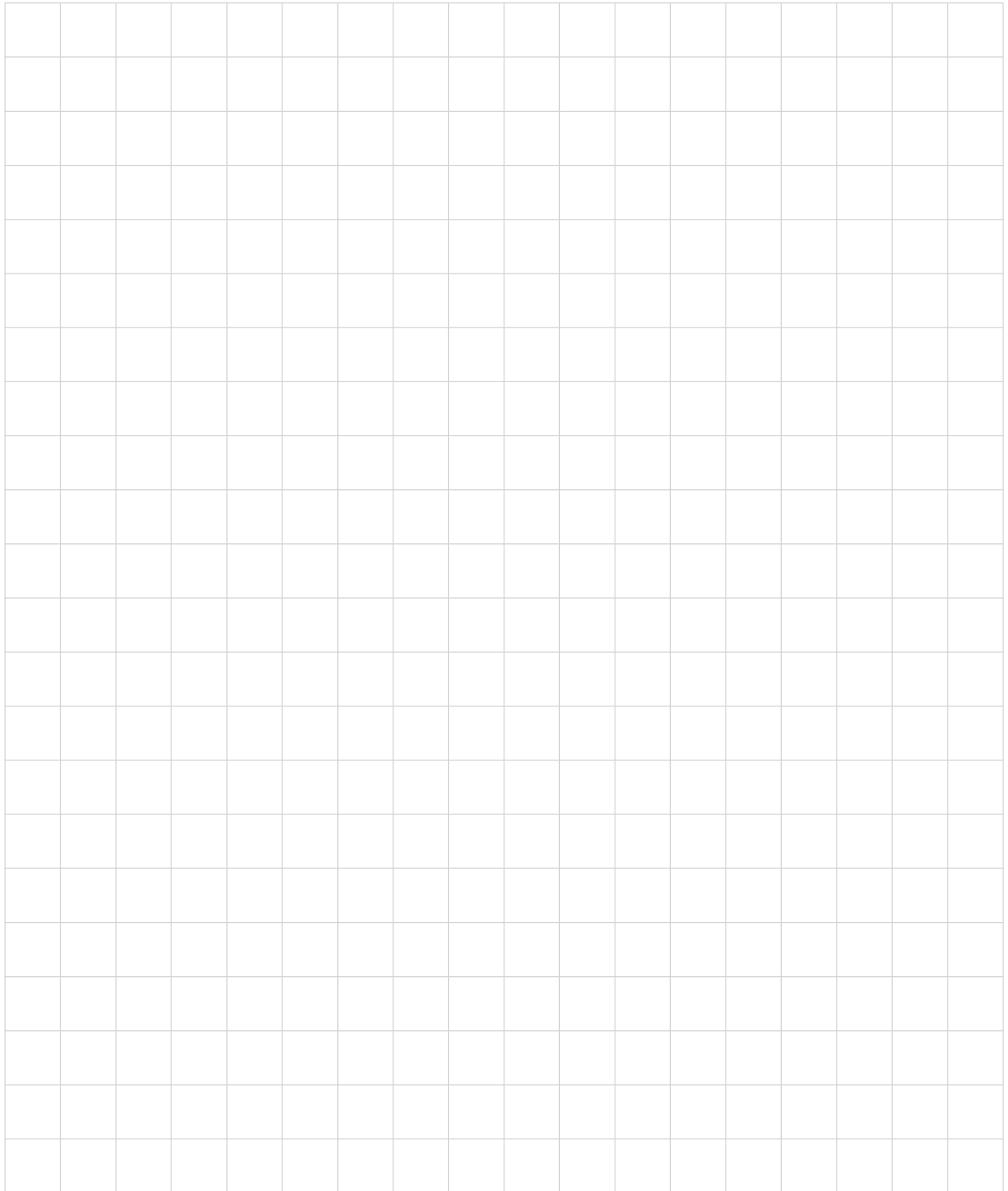



Válvulas Solenoides 3/2

Válvulas Serie VSD (1/8")	Válvulas-78
Válvulas Serie VSP (1/8", 1/4", 3/8")	Válvulas-79



Válvulas Solenoides 5/2 y 5/3

Válvulas Serie VSP (1/8", 1/4", 3/8", 1/2")	Válvulas-80
Bobinas Serie VSB	Válvulas-83
Manifolds Serie VSM	Válvulas-83



Válvulas Solenoides 5/2 Tipo Namur

Válvulas Serie VSN (1/4", 3/8")	Válvulas-85
--	-------------



Válvulas Solenoides 5/2 De Alto Ciclaje

Válvulas Serie VSA (1/4")	Válvulas-86
Bobinas Serie VSAB	Válvulas-86



Válvulas Solenoides 5/2 y 5/3 ISO 1 - ISO 2 - ISO 3

Válvulas Serie VSI (1/4", 3/8", 1/2")	Válvulas-88
--	-------------



Válvulas Neumáticas 3/2

Válvulas **Serie VN** (1/8", 1/4", 3/8")

Válvulas-93



Válvulas Neumáticas 5/2 y 5/3

Válvulas **Serie VN** (1/8", 1/4", 3/8", 1/2")

Válvulas-94

Manifolds **Serie VSMM**

Válvulas-95



Válvulas Miniatura Manuales y Mecánicas 3/2

Válvulas Miniatura **Serie VMM** (1/8")

Válvulas-98



Válvulas Manuales y Mecánicas 3/2

Válvulas **Serie VM** (1/8", 1/4")

Válvulas-100



Válvulas Manuales 3/2 y 5/2

Válvulas **Serie VMC** (1/8")

Válvulas-102



Válvulas De Botón 3/2 y 5/2

Válvulas **Serie VB** (1/4", 3/8") Válvulas-104



Válvulas De Pedal 3/2 y 5/2

Válvulas Plásticas **Serie VPP** (1/4") Válvulas-105

Válvulas **Serie VP** Válvulas-105



Válvulas Manuales y Mecánicas 5/2

Válvulas **Serie VM** (1/4") Válvulas-106



Válvulas De Palanca 5/2 y 5/3

Válvulas **Serie VPA** (1/8", 1/4", 3/8") Válvulas-108



Válvulas Rotativas 4/2 - 4/3

Válvulas **Serie VR** (1/4", 3/8", 1/2") Válvulas-109

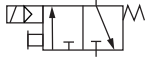

Características

- Acción directa
- Normalmente cerradas
- Regreso resorte
- Operador manual adicional
- Fácil montaje en manifold



Datos Técnicos

Fluido:
 Aire comprimido Filtrado,
 lubricado o no lubricado

Presión de Trabajo:
 0 a 8 Bar ~ 0 a 114 PSI

Temperatura de Trabajo:
 -5°C a 60°C ~ 23°F a 140°F

Tiempo de Respuesta:
 0,05 segundos

Max. Ciclaje:
 10 Ciclos/segundo

Materiales

Cuerpo : Aluminio
 Sellos : NBR

Modelos Standard

Referencia	NPT	Operador	Voltaje	CV
VSD02011	1/8"	Solenoid - Resorte	12 DC	0,07
VSD02012	1/8"	Solenoid - Resorte	24 DC	0,07
VSD02014	1/8"	Solenoid - Resorte	110 AC	0,07
VSD02015	1/8"	Solenoid - Resorte	220 AC	0,07

Incluyen conector eléctrico tipo DIN 43650B con LED indicador

Bobinas y Conectores

Referencia	Descripción	Potencia
VSB1	Bobina 12 DC	2,5 W
VSB2	Bobina 24 DC	3,0 W
VSB3	Bobina 24 AC	3,5 VA
VSB4	Bobina 110 AC	2,5 VA
VSB5	Bobina 220 AC	2,0 VA
VSC1	Conector eléctrico DC con LED indicador	
VSC2	Conector eléctrico AC con LED indicador	
VSDS01	Soporte de Montaje	
VSDK01	Kit de ensamble, permite conectar hasta 4 válvulas	

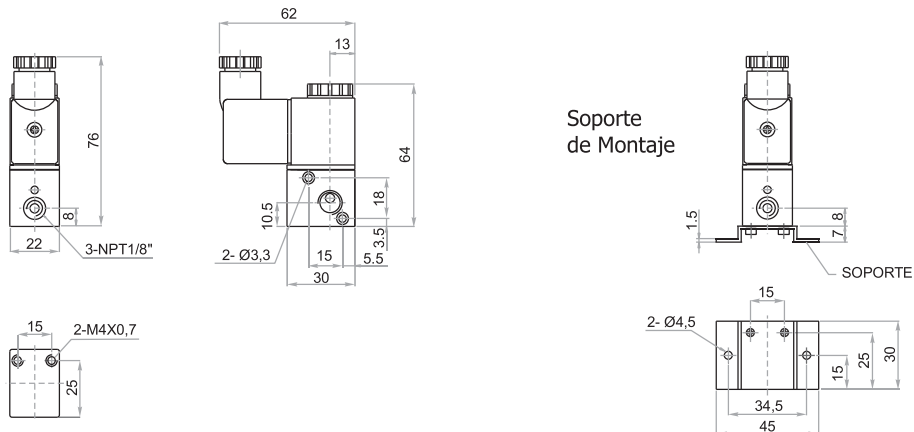

VALVULAS SOLENOIDES 3/2

SERIE VSP 1/8 - 1/4 - 3/8 NPT

Art

VALVULAS

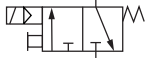

Características

- Servopilotadas
- Normalmente cerradas
- Regreso resorte
- Operador manual adicional
- *VSPM: 1/8" NPT con cuerpo pequeño

Datos Técnicos

Fluido:
Aire comprimido Filtrado,
lubricado o no lubricado

Presión de Trabajo:
1,5 a 8 Bar ~ 21 a 114 PSI

Temperatura de Trabajo:
-5°C a 60°C ~ 23°F a 140°F

Tiempo de Respuesta:
0,05 segundos

Max. Ciclaje:
5 Ciclos/segundo

Materiales

Cuerpo : Aluminio
Carrete : Aluminio
Sellos : NBR
Resorte : Acero Inoxidable

Modelos Standard

Referencia	NPT	Operador	Voltaje	CV
VSPM02011	*1/8"	Solenoide - Resorte	12 DC	0,67
VSPM02012	*1/8"	Solenoide - Resorte	24 DC	0,67
VSPM02014	*1/8"	Solenoide - Resorte	110 AC	0,67
VSPM02015	*1/8"	Solenoide - Resorte	220 AC	0,67
VSP02011	1/8"	Solenoide - Resorte	12 DC	0,78
VSP02012	1/8"	Solenoide - Resorte	24 DC	0,78
VSP02014	1/8"	Solenoide - Resorte	110 AC	0,78
VSP02015	1/8"	Solenoide - Resorte	220 AC	0,78
VSP02021	1/4"	Solenoide - Resorte	12 DC	0,89
VSP02022	1/4"	Solenoide - Resorte	24 DC	0,89
VSP02024	1/4"	Solenoide - Resorte	110 AC	0,89
VSP02025	1/4"	Solenoide - Resorte	220 AC	0,89
VSP02031	3/8"	Solenoide - Resorte	12 DC	1,67
VSP02032	3/8"	Solenoide - Resorte	24 DC	1,67
VSP02034	3/8"	Solenoide - Resorte	110 AC	1,67
VSP02035	3/8"	Solenoide - Resorte	220 AC	1,67

Incluyen conector eléctrico tipo DIN 43650B con LED indicador
Vea las bobinas para las válvulas miniatura en la pág. [Válvulas - 07](#)

Bobinas y Conectores

Referencia	Descripción	Potencia
VSB1	Bobina 12 DC	2,5 W
VSB2	Bobina 24 DC	2,5 W
VSB3	Bobina 24 AC	3,5 VA
VSB4	Bobina 110 AC	3,5 VA
VSB5	Bobina 220 AC	3,5 VA
VSC1	Conector eléctrico DC con LED indicador	
VSC2	Conector eléctrico AC con LED indicador	

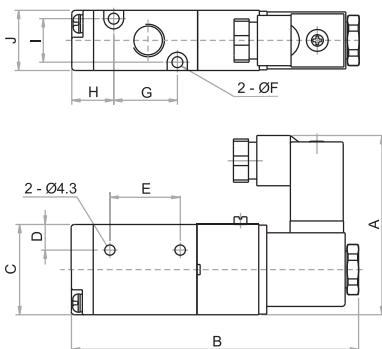

NPT	A	B	C	D	E
1/8 Mini	55	88,4	27	7,7	21
1/8	66,7	109	35	8,2	25
1/4	66,7	109	35	8,2	25
3/8	69,2	120	40	10,5	30

NPT	ØF	G	H	I	J
1/8 Mini	3,2	19	13,2	13	18
1/8	3,2	30	12,7	17	22
1/4	3,2	30	12,7	17	22
3/8	4,3	35	15	20	27

Art

Válvulas-79

Características

- Servopilotadas
- Operador manual adicional
- Libres de mantenimiento
- Bajo consumo de potencia
- Fácil montaje en manifold



Datos Técnicos

Fluido:
 Aire comprimido Filtrado,
 lubricado o no lubricado

Presión de Trabajo:
 1,5 a 8 Bar ~ 21 a 114 PSI

Temperatura de Trabajo:
 -5°C a 60°C ~ 23°F a 140°F

Tiempo de Respuesta:
 0,05 segundos

Conector Eléctrico:
 Tipo DIN 43650B
 con LED indicador



5/2 Solenoide - Resorte

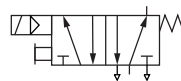

5/2 Doble Solenoide

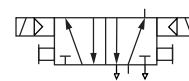

Materiales

Cuerpo : Aluminio
 Carrete : Aluminio
 Sellos : NBR

5/3 Centros Cerrados

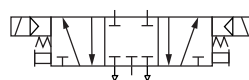

5/3 Centros Abiertos

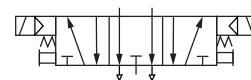

VALVULAS SOLENOIDES 5/2 y 5/3

SERIE VSP 1/8 - 1/4 NPT

Art

VALVULAS

Modelos Standard

Referencia	Vías	NPT	Operador	Voltaje	CV	Ciclos/Seg.
VSPM08011	5/2	*1/8"	Solenoide - Resorte	12 DC	0,67	5
VSPM08012	5/2	*1/8"	Solenoide - Resorte	24 DC	0,67	5
VSPM08014	5/2	*1/8"	Solenoide - Resorte	110 AC	0,67	5
VSPM08015	5/2	*1/8"	Solenoide - Resorte	220 AC	0,67	5
VSPM09011	5/2	*1/8"	Doble Solenoide	12 DC	0,67	5
VSPM09012	5/2	*1/8"	Doble Solenoide	24 DC	0,67	5
VSPM09014	5/2	*1/8"	Doble Solenoide	110 AC	0,67	5
VSPM09015	5/2	*1/8"	Doble Solenoide	220 AC	0,67	5
VSP08011	5/2	1/8"	Solenoide - Resorte	12 DC	0,78	5
VSP08012	5/2	1/8"	Solenoide - Resorte	24 DC	0,78	5
VSP08014	5/2	1/8"	Solenoide - Resorte	110 AC	0,78	5
VSP08015	5/2	1/8"	Solenoide - Resorte	220 AC	0,78	5
VSP09011	5/2	1/8"	Doble Solenoide	12 DC	0,78	5
VSP09012	5/2	1/8"	Doble Solenoide	24 DC	0,78	5
VSP09014	5/2	1/8"	Doble Solenoide	110 AC	0,78	5
VSP09015	5/2	1/8"	Doble Solenoide	220 AC	0,78	5
VSP10011	5/3	1/8"	Centros Cerrados	12 DC	0,67	3
VSP10012	5/3	1/8"	Centros Cerrados	24 DC	0,67	3
VSP10014	5/3	1/8"	Centros Cerrados	110 AC	0,67	3
VSP10015	5/3	1/8"	Centros Cerrados	220 AC	0,67	3
VSP11011	5/3	1/8"	Centros Abiertos	12 DC	0,67	3
VSP11012	5/3	1/8"	Centros Abiertos	24 DC	0,67	3
VSP11014	5/3	1/8"	Centros Abiertos	110 AC	0,67	3
VSP11015	5/3	1/8"	Centros Abiertos	220 AC	0,67	3
VSP08021	5/2	1/4"	Solenoide - Resorte	12 DC	0,89	5
VSP08022	5/2	1/4"	Solenoide - Resorte	24 DC	0,89	5
VSP08024	5/2	1/4"	Solenoide - Resorte	110 AC	0,89	5
VSP08025	5/2	1/4"	Solenoide - Resorte	220 AC	0,89	5
VSP09021	5/2	1/4"	Doble Solenoide	12 DC	0,89	5
VSP09022	5/2	1/4"	Doble Solenoide	24 DC	0,89	5
VSP09024	5/2	1/4"	Doble Solenoide	110 AC	0,89	5
VSP09025	5/2	1/4"	Doble Solenoide	220 AC	0,89	5
VSP10021	5/3	1/4"	Centros Cerrados	12 DC	0,67	3
VSP10022	5/3	1/4"	Centros Cerrados	24 DC	0,67	3
VSP10024	5/3	1/4"	Centros Cerrados	110 AC	0,67	3
VSP10025	5/3	1/4"	Centros Cerrados	220 AC	0,67	3
VSP11021	5/3	1/4"	Centros Abiertos	12 DC	0,67	3
VSP11022	5/3	1/4"	Centros Abiertos	24 DC	0,67	3
VSP11024	5/3	1/4"	Centros Abiertos	110 AC	0,67	3
VSP11025	5/3	1/4"	Centros Abiertos	220 AC	0,67	3

* VSPM 1/8" NPT con cuerpo pequeño

Art

Válvulas-81

VALVULAS SOLENOIDES 5/2 y 5/3

SERIE VSP 3/8 - 1/2 NPT

Art

Modelos Standard

Referencia	Vías	NPT	Operador	Voltaje	CV	Ciclos/Seg.
VSP08031	5/2	3/8"	Solenoide - Resorte	12 DC	1,68	5
VSP08032	5/2	3/8"	Solenoide - Resorte	24 DC	1,68	5
VSP08034	5/2	3/8"	Solenoide - Resorte	110 AC	1,68	5
VSP08035	5/2	3/8"	Solenoide - Resorte	220 AC	1,68	5
VSP09031	5/2	3/8"	Doble Solenoide	12 DC	1,68	5
VSP09032	5/2	3/8"	Doble Solenoide	24 DC	1,68	5
VSP09034	5/2	3/8"	Doble Solenoide	110 AC	1,68	5
VSP09035	5/2	3/8"	Doble Solenoide	220 AC	1,68	5
VSP10031	5/3	3/8"	Centros Cerrados	12 DC	1,00	3
VSP10032	5/3	3/8"	Centros Cerrados	24 DC	1,00	3
VSP10034	5/3	3/8"	Centros Cerrados	110 AC	1,00	3
VSP10035	5/3	3/8"	Centros Cerrados	220 AC	1,00	3
VSP11031	5/3	3/8"	Centros Abiertos	12 DC	1,00	3
VSP11032	5/3	3/8"	Centros Abiertos	24 DC	1,00	3
VSP11034	5/3	3/8"	Centros Abiertos	110 AC	1,00	3
VSP11035	5/3	3/8"	Centros Abiertos	220 AC	1,00	3
VSP08041	5/2	1/2"	Solenoide - Resorte	12 DC	2,79	3
VSP08042	5/2	1/2"	Solenoide - Resorte	24 DC	2,79	3
VSP08044	5/2	1/2"	Solenoide - Resorte	110 AC	2,79	3
VSP08045	5/2	1/2"	Solenoide - Resorte	220 AC	2,79	3
VSP09041	5/2	1/2"	Doble Solenoide	12 DC	2,79	3
VSP09042	5/2	1/2"	Doble Solenoide	24 DC	2,79	3
VSP09044	5/2	1/2"	Doble Solenoide	110 AC	2,79	3
VSP09045	5/2	1/2"	Doble Solenoide	220 AC	2,79	3
VSP10041	5/3	1/2"	Centros Cerrados	12 DC	1,67	3
VSP10042	5/3	1/2"	Centros Cerrados	24 DC	1,67	3
VSP10044	5/3	1/2"	Centros Cerrados	110 AC	1,67	3
VSP10045	5/3	1/2"	Centros Cerrados	220 AC	1,67	3
VSP11041	5/3	1/2"	Centros Abiertos	12 DC	1,67	3
VSP11042	5/3	1/2"	Centros Abiertos	24 DC	1,67	3
VSP11044	5/3	1/2"	Centros Abiertos	110 AC	1,67	3
VSP11045	5/3	1/2"	Centros Abiertos	220 AC	1,67	3

MANIFOLD PARA VALVULAS 5/2 y 5/3

SERIE VSP 1/8 - 1/4 - 3/8 - 1/2 NPT

Art

Manifolds

Los manifolds permiten instalar un conjunto de válvulas facilitando el montaje al utilizar una única entrada, reduciendo así la cantidad de racores, manguera y silenciadores.

Admiten combinar cualquier válvula solenoide serie VSP 5/2 ó 5/3, y válvulas de piloto neumático serie VN 5/2 ó 5/3, para mayor versatilidad.

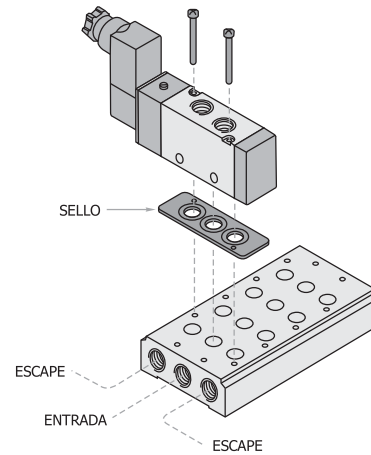

Modelos Standard

Válvula	Para Válvulas 1/8" Mini.	Para Válvulas de 1/8" y 1/4"	Para Válvulas de 3/8"	Para Válvulas de 1/2"
No. Estaciones	Referencia	Referencia	Referencia	Referencia
2	VSMM502	VSM0202	VSM0302	VSM0402
3	VSMM503	VSM0203	VSM0303	VSM0403
4	VSMM504	VSM0204	VSM0304	VSM0404
5	VSMM505	VSM0205	VSM0305	VSM0405
6	VSMM506	VSM0206	VSM0306	VSM0406
7	VSMM507	VSM0207	VSM0307	VSM0407
8	VSMM508	VSM0208	VSM0308	
9	VSMM509	VSM0209	VSM0309	
10	VSMM510	VSM0210	VSM0310	
11	VSMM511	VSM0211	VSM0311	
12	VSMM512	VSM0212	VSM0312	
*Placa	VSMTM5	VSMT02	VSMT03	VSMT04
Entradas	1/4"	1/4"	3/8"	1/2"

* Esta placa permite bloquear una de las salidas del manifold



Bobinas para serie VSP 1/8" Mini.

Referencia	Descripción	Potencia
VSBM51	Bobina 12 VDC	2,5 W
VSBM52	Bobina 24 VDC	2,5 W
VSBM53	Bobina 24 VAC	3,0 VA
VSBM54	Bobina 110 VAC	3,0 VA
VSBM55	Bobina 220 VAC	3,0 VA
VSCM51	Conector eléctrico transparente	

Bobinas serie VSP 1/8", 1/4", 3/8" y 1/2"

Referencia	Descripción	Potencia
VSB1	Bobina 12 VDC	2,5 W
VSB2	Bobina 24 VDC	2,5 W
VSB3	Bobina 24 VAC	3,5 VA
VSB4	Bobina 110 VAC	3,5 VA
VSB5	Bobina 220 VAC	3,5 VA
VSC1	Conector eléctrico DC con LED indicador	
VSC2	Conector eléctrico AC con LED indicador	

VALVULAS SOLENOIDES 5/2 y 5/3

SERIE VSP 1/8 - 1/4 - 3/8 - 1/2 NPT

Art

Válvulas 5/2

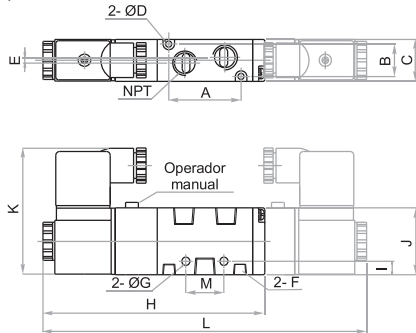

NPT	A	B	C	ØD	E	F	ØG
1/8" Mini	30	13	18	3,3	0	M5 x 8	3,3
1/8"	38	17	22	3,2	0	1/8"	4,3
1/4"	38	17	22	3,2	3	1/8"	4,3
3/8"	50	20	27	4,3	4	1/4"	4,3
1/2"	72	27	34	4,3	4	1/2"	5,5

Válvulas 5/3

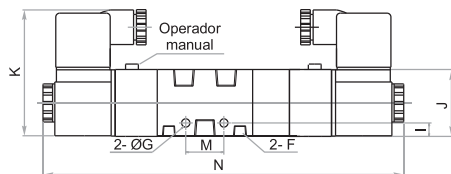

NPT	H	I	J	K	L	M	N
1/8" Mini	99,4	4	27	55	142,4	14	157,4
1/8"	117	7	35	66,7	171	20	190
1/4"	117	7	35	66,7	171	20	190
3/8"	135	6,5	40	69,2	190	24	209
1/2"	168,4	7,5	50	74,2	222,8	28	243,8

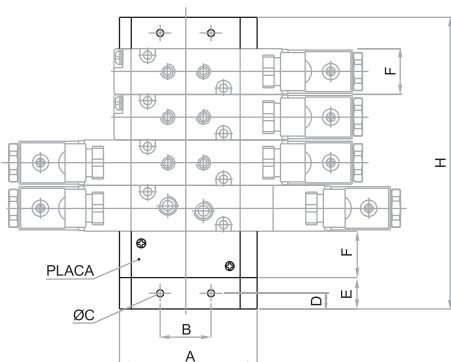
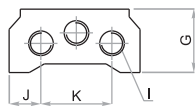

Manifolds

Serie	A	B	C	D	E	F	G
VSMM5	58	20	4,5	5	10	18,3	25
VSM02	61	21	4,5	6	12	22,4	26
VSM03	75	26	4,5	6	13,5	27,3	30
VSM04	104	32	5,5	7	14,5	34,3	38

Serie	2H	3H	4H	5H	6H	7H	8H
VSMM5	57	76	95	114	133	152	171
VSM02	69	92	115	138	161	184	207
VSM03	82	110	138	166	194	222	250
VSM04	98	133	168	203	238	273	-

Serie	9H	10H	11H	12H	I	J	K
VSMM5	190	209	228	247	1/4"	9	40
VSM02	230	253	276	299	1/4"	9	43
VSM03	278	306	334	362	3/8"	11	53
VSM04	-	-	-	-	1/2"	18	68

VALVULAS SOLENOIDES 5/2

SERIE VSN - NAMUR 1/4 - 3/8 NPT

Art

VALVULAS

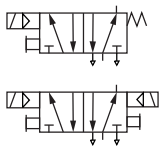

Las válvulas Namur están especialmente diseñadas para instalar directamente sobre los actuadores rotativos, eliminando así racores y mangueras

Características

- Servopilotadas
- Bajo consumo de potencia
- Operador manual adicional
- Libres de mantenimiento

Datos Técnicos

Fluido:
Aire comprimido Filtrado,
lubricado o no lubricado

Presión de Trabajo:
1,5 a 8 Bar ~ 21 a 114 PSI

Temperatura de Trabajo:
-5°C a 60°C ~ 23°F a 140°F

Tiempo de Respuesta:
0,05 segundos

Max. Ciclaje:
5 Ciclos/segundo

Materiales

Cuerpo : Aluminio
Carrete : Aluminio
Sellos : NBR
Resorte : Acero Inoxidable

Modelos Standard

Referencia	NPT	Operador	Voltaje	CV
VSN08021	1/4"	Solenoido - Resorte	12 DC	1,40
VSN08022	1/4"	Solenoido - Resorte	24 DC	1,40
VSN08024	1/4"	Solenoido - Resorte	110 AC	1,40
VSN08025	1/4"	Solenoido - Resorte	220 AC	1,40
VSN09021	1/4"	Doble Solenoido	12 DC	1,40
VSN09022	1/4"	Doble Solenoido	24 DC	1,40
VSN09024	1/4"	Doble Solenoido	110 AC	1,40
VSN09025	1/4"	Doble Solenoido	220 AC	1,40
VSN08031	3/8"	Solenoido - Resorte	12 DC	1,68
VSN08032	3/8"	Solenoido - Resorte	24 DC	1,68
VSN08034	3/8"	Solenoido - Resorte	110 AC	1,68
VSN08035	3/8"	Solenoido - Resorte	220 AC	1,68

Incluyen conector eléctrico tipo DIN 43650B con LED indicador

Bobinas y Conectores

Referencia	Descripción	Potencia
VSB1	Bobina 12 VDC	2,5 W
VSB2	Bobina 24 VDC	2,5 W
VSB3	Bobina 24 VAC	3,5 VA
VSB4	Bobina 110 VAC	3,5 VA
VSB5	Bobina 220 VAC	3,5 VA
VSC1	Conector eléctrico DC con LED indicador	
VSC2	Conector eléctrico AC con LED indicador	

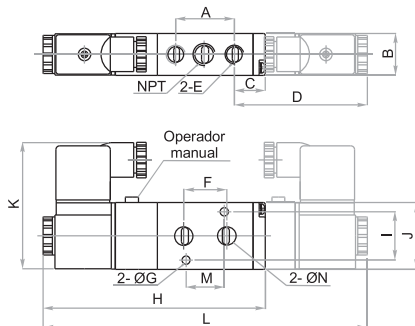

NPT	A	B	C	D	E	F	ØG
1/4	45	27	17,5	72,4	1/4"	22	5,2
3/8	45	27	17,5	-	1/4"	22	5,2

NPT	H	I	J	K	L	M	ØN
1/4	135	32	40	69	190	24	19,2
3/8	135	32	40	69	-	24	19,2

Art

Válvulas-85

VALVULAS SOLENOIDES 5/2 - ALTO CICLAJE

SERIE VSA 1/4 NPT - 1.200 CICLOS POR MINUTO

Art



Características

- Gran caudal
- Sello metálico
- 1.200 ciclos por minuto
- Vida útil de 100 millones de ciclos

Modelos Standard

Referencia	NPT	Operador	Voltaje	CV
VSA08022	1/4"	Solenoide - Resorte	24 DC	2,0
VSA08023	1/4"	Solenoide - Resorte	24 AC	2,0
VSA08024	1/4"	Solenoide - Resorte	120 AC	2,0
VSA08025	1/4"	Solenoide - Resorte	220 AC	2,0

Incluyen conector eléctrico tipo DIN 43650B

Datos Técnicos

Fluido:
Aire comprimido y gases inertes

Presión de Trabajo:
1,5 a 10 Bar ~ 22 a 145 PSI

Diferencial de Presión:
10,3 Bar ~ 150 PSI

Temperatura de Trabajo:
-10°C a 60°C ~ 14°F a 140°F

Frecuencia de Operación:
1200 ciclos/minuto

Tiempo de Respuesta:
20 ms.

Bobinas

Referencia	Descripción	Potencia
VSAB2	Bobina 24 DC	1,8 W
VSAB3	Bobina 24 AC	5 VA
VSAB4	Bobina 110 AC	5 VA
VSAB5	Bobina 220 AC	5 VA

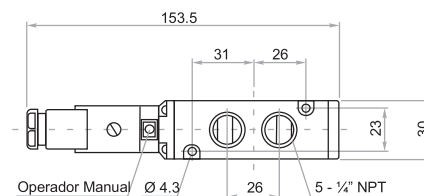

Materiales

Cuerpo : Aluminio
Carrete y
Camisa : Acero Inoxidable
Resorte : Acero Inoxidable
Tapa : Resina sintética

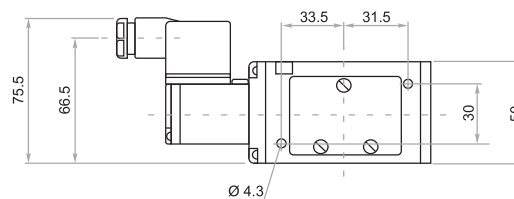

Características

- Piloto interno estándar, puede convertirse a piloto externo al cambiar la dirección del sello
- Permite seleccionar entre base individual ó base en manifold
- Las bases poseen control de flujo que regula la salida del aire en el escape
- Operador manual adicional
- Libres de mantenimiento
- Bajo consumo de potencia
- Protección IP65



Datos Técnicos

Fluido:
 Aire comprimido Filtrado,
 lubricado o no lubricado

Presión de Trabajo:
 2 a 10 Bar ~ 29 a 145 PSI

Temperatura de Trabajo:
 -20°C a 70°C ~ -4°F a 158°F

Tiempo de Respuesta:
 ISO 1: 33 ms
 ISO 2: 42 ms
 ISO 3: 50 ms



5/2 Solenoide - Resorte

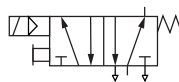

5/2 Doble Solenoide

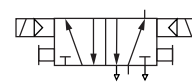

Materiales

Cuerpo : Aluminio

Carrete : Aluminio

Sellos : NBR

5/3 Centros Cerrados

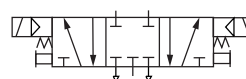

Válvulas ISO 1

Referencia	Vías	Rosca G	Operador	Voltaje	Ciclos/Segundo	CV
VSI08024	5/2	1/4	Solenoides - Resorte	110 AC	10	1,5
VSI09024	5/2	1/4	Doble Solenoide	110 AC	10	1,5
VSI10024	5/3	1/4	Centros Cerrados	110 AC	10	1,5
VSIB02	-	1/4	Sub-base individual			
VSISB02	-	1/4	Sub-base Manifold			
VSIT02	-	3/8	Tapa Lateral			
VSIP02	-	-	Placa (Permite bloquear la parte superior del manifold para facilitar el mantenimiento)			

Incluyen conector eléctrico tipo DIN 43650B con LED indicador

Válvulas ISO 2

Referencia	Vías	Rosca G	Operador	Voltaje	Ciclos/Segundo	CV
VSI08034	5/2	3/8	Solenoides - Resorte	110 AC	7	2,0
VSI09034	5/2	3/8	Doble Solenoide	110 AC	7	2,0
VSI10034	5/3	3/8	Centros Cerrados	110 AC	7	2,0
VSIB03	-	3/8	Sub-base individual			
VSISB03	-	3/8	Sub-base Manifold			
VSIT03	-	1/2	Tapa Lateral			
VSIP03	-	-	Placa (Permite bloquear la parte superior del manifold para facilitar el mantenimiento)			

Incluyen conector eléctrico tipo DIN 43650B con LED indicador

Válvulas ISO 3

Referencia	Vías	Rosca G	Operador	Voltaje	Ciclos/Segundo	CV
VSI08044	5/2	1/2	Solenoides - Resorte	110 AC	7	3,5
VSI09044	5/2	1/2	Doble Solenoide	110 AC	7	3,5
VSI10044	5/3	1/2	Centros Cerrados	110 AC	7	3,5
VSIB04	-	1/2	Sub-base individual			
VSISB04	-	1/2	Sub-base Manifold			
VSIT04	-	3/4	Tapa Lateral			
VSIP04	-	-	Placa (Permite bloquear la parte superior del manifold para facilitar el mantenimiento)			

Incluyen conector eléctrico tipo DIN 43650B con LED indicador

Válvulas ISO 1

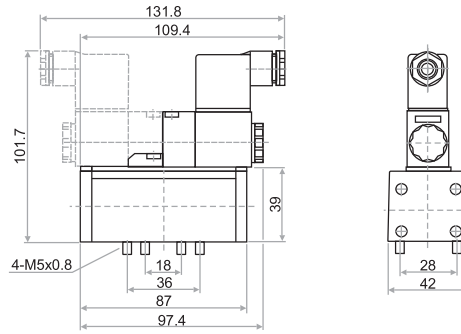

Válvulas ISO 1
 sub-base Individual

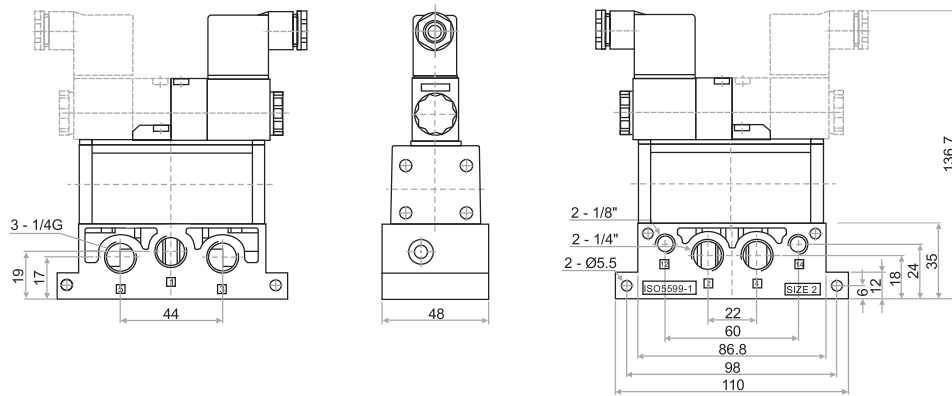

Válvulas ISO 1
 sub-base Manifold

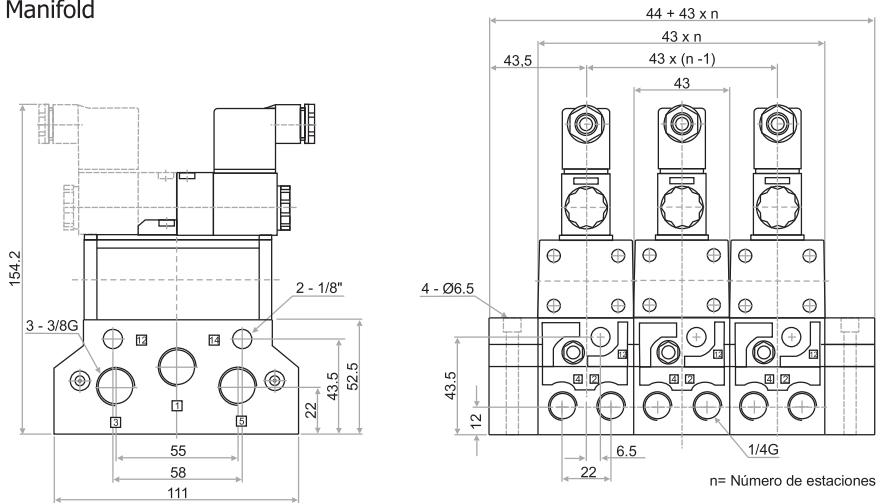

Válvulas **ISO 2**

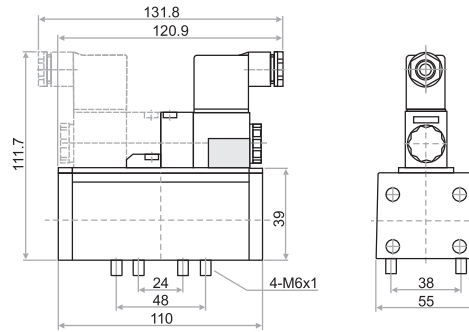

Válvulas **ISO 2**
 sub-base Individual

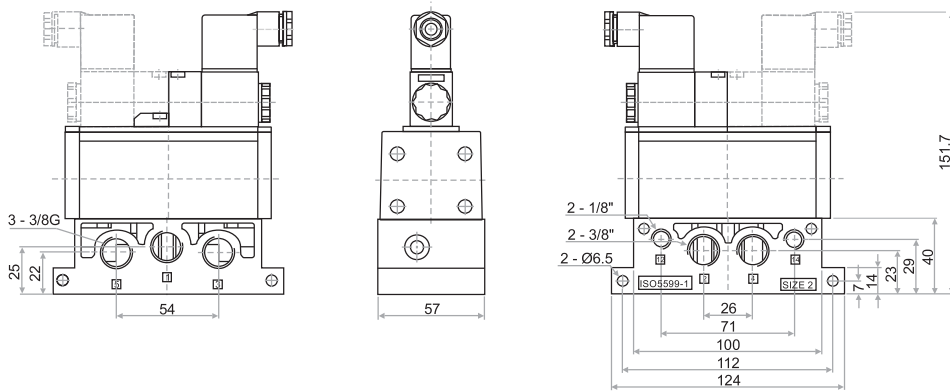

Válvulas **ISO 2**
 sub-base Manifold

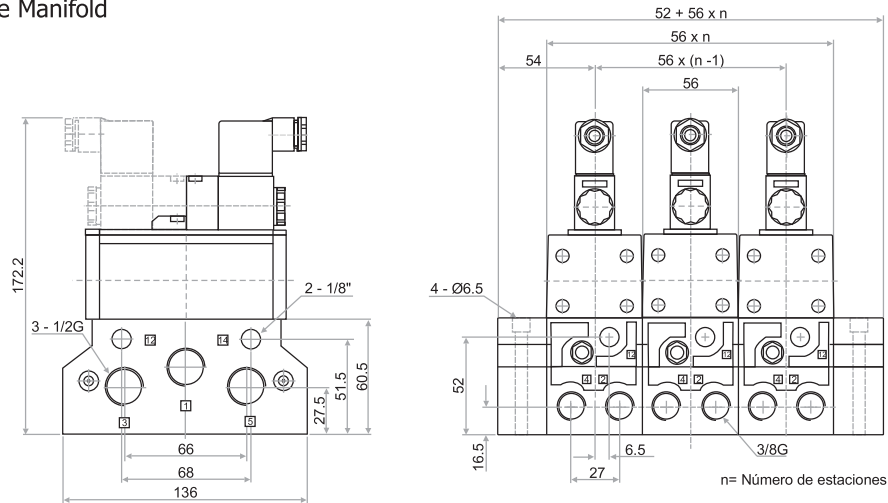

Válvulas **ISO 3**

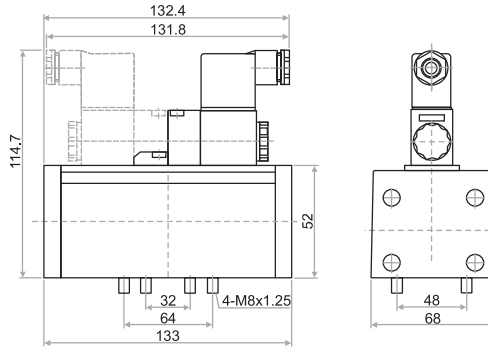

Válvulas **ISO 3**
 sub-base Individual

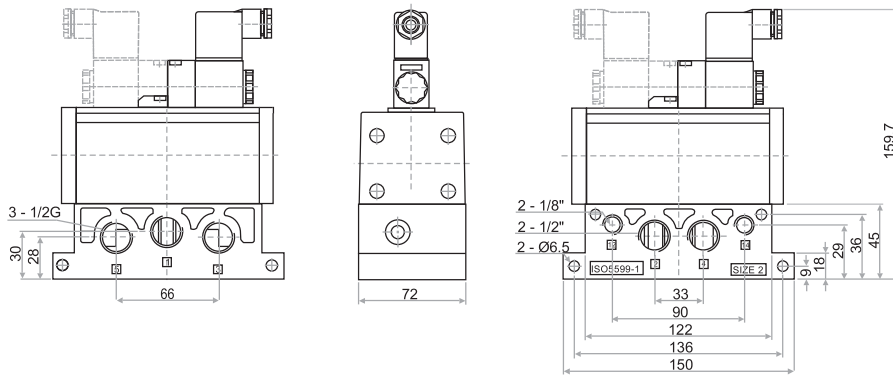

Válvulas **ISO 3**
 sub-base Manifold

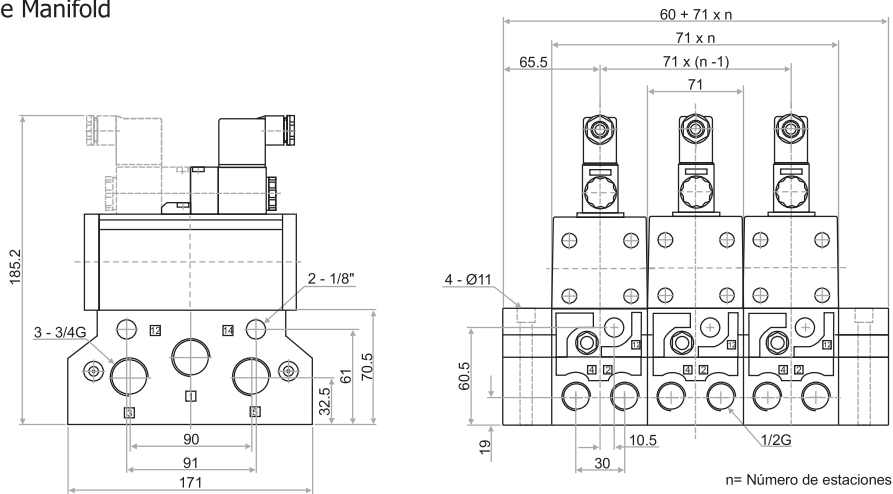

VALVULAS CON PILOTO NEUMATICO 3/2

SERIE VN 1/8 - 1/4 - 3/8 NPT

Art

VALVULAS

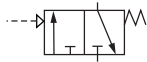

Características

- Normalmente cerradas
- Regreso resorte
- Libres de mantenimiento

Modelos Standard

Referencia	NPT	Operador	Vías	CV
VN0201	1/8"	Aire - Resorte	3/2	0,67
VN0202	1/4"	Aire - Resorte	3/2	0,89
VN0203	3/8"	Aire - Resorte	3/2	1,67

Datos Técnicos

Fluido:

Aire comprimido Filtrado, lubricado o no lubricado

Presión de Trabajo:

1,5 a 8 Bar ~ 21 a 114 PSI

Temperatura de Trabajo:

-5°C a 60°C ~ 23°F a 140°F

Max. Ciclaje:

5 Ciclos/segundo

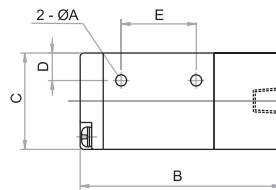
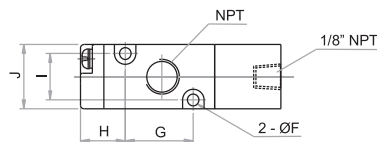

Materiales

Cuerpo : Aluminio
 Carrete : Aluminio
 Sellos : NBR
 Resorte : Acero Inoxidable

NPT	ØA	B	C	D	E	ØF	G	H	I	J
1/8"	3,3	56,5	27	7,7	21	3,3	19	12,5	13	18
1/4"	4,3	70	35	8	25	3,2	30	12,5	17	22
3/8"	4,3	80,5	40	10,5	30	4,3	35	15	20	27

VALVULAS CON PILOTO NEUMATICO 5/2 y 5/3

SERIE VN 1/8 - 1/4 - 3/8 - 1/2 NPT

Art



Características

- Regreso resorte
- Doble piloto neumático
- Libres de mantenimiento
- Fácil montaje en manifold

5/2 Aire - Resorte

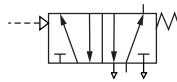

5/2 Doble Aire

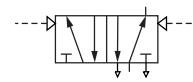

Datos Técnicos

Fluido:
Aire comprimido Filtrado,
lubricado o no lubricado

Presión de Trabajo:
1,5 a 8 Bar ~ 21 a 114 PSI

Temperatura de Trabajo:
-5°C a 60°C ~ 23°F a 140°F

Max. Ciclaje:

En Válvulas 5/2:
5 Ciclos/segundo

En Válvulas 5/3:
3 Ciclos/segundo

En Válvulas de 1/2:
3 Ciclos/segundo

5/3 Centros Cerrados

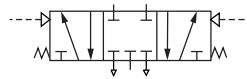

5/3 Centros Abiertos

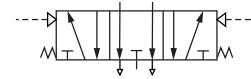

Modelos Standard

Referencia	NPT	Operador	Voltaje	CV
VN0801	1/8"	Aire / Resorte	5/2	0,67
VN0901	1/8"	Aire / Aire	5/2	0,67
VN1001	1/8"	Centros Cerrados	5/3	0,50
VN1101	1/8"	Centros Abiertos	5/3	0,50
VN0802	1/4"	Aire / Resorte	5/2	0,89
VN0902	1/4"	Aire / Aire	5/2	0,89
VN1002	1/4"	Centros Cerrados	5/3	0,67
VN1102	1/4"	Centros Abiertos	5/3	0,67
VN0803	3/8"	Aire / Resorte	5/2	1,67
VN0903	3/8"	Aire / Aire	5/2	1,67
VN0804	1/2"	Aire / Resorte	5/2	2,79
VN0904	1/2"	Aire / Aire	5/2	2,79

Materiales

Cuerpo : Aluminio

Carrete : Aluminio

Sellos : NBR

MANIFOLD PARA VALVULAS 5/2 y 5/3

SERIE VN 1/8 - 1/4 - 3/8 - 1/2 NPT

Art

Manifolds

Los manifolds permiten instalar un conjunto de válvulas facilitando el montaje al utilizar una única entrada, reduciendo así la cantidad de racores, manguera y silenciadores.

Admiten combinar cualquier válvula de piloto neumático serie VN 5/2 ó 5/3, y válvulas solenoides serie VSP 5/2 ó 5/3, para mayor versatilidad.

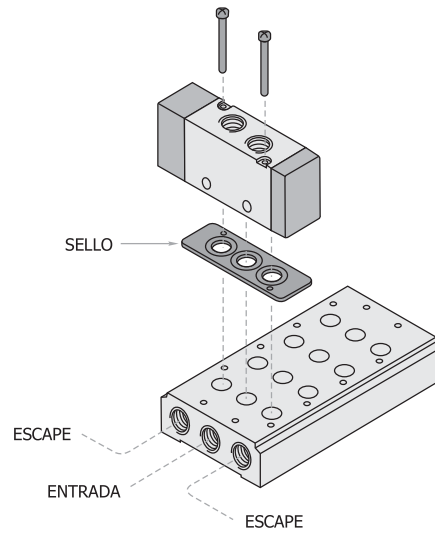

Modelos Standard

Válvula	Para Válvulas de 1/8" y 1/4"	Para Válvulas de 3/8"	Para Válvulas de 1/2"
No. Estaciones	Referencia	Referencia	Referencia
2	VSM0202	VSM0302	VSM0402
3	VSM0203	VSM0303	VSM0403
4	VSM0204	VSM0304	VSM0404
5	VSM0205	VSM0305	VSM0405
6	VSM0206	VSM0306	VSM0406
7	VSM0207	VSM0307	VSM0407
8	VSM0208	VSM0308	
9	VSM0209	VSM0309	
10	VSM0210	VSM0310	
11	VSM0211	VSM0311	
12	VSM0212	VSM0312	
*Placa	VSMT02	VSMT03	VSMT04
Entradas	1/4"	3/8"	1/2"

* Esta placa permite bloquear una de las salidas del manifold

VALVULAS CON PILOTO NEUMATICO 5/2 y 5/3

SERIE VN 1/8 - 1/4 - 3/8 - 1/2 NPT

Art

Válvulas 5/2

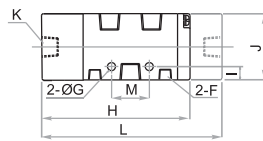
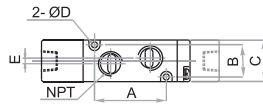

Válvulas 5/3

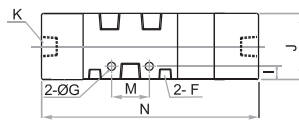

NPT	A	B	C	ØD	E	F	ØG
1/8"	30	13	18	3,3	3	1/8"	3,3
1/4"	38	17	22	3,2	3	1/8"	4,3
3/8"	50	20	27	4,3	4	1/4"	4,3
1/2"	72	27	34	4,3	4	1/2"	5,5

NPT	H	I	J	K	L	M	N
1/8"	68,7	4	27	1/8"	81	14	96
1/4"	77,7	7	35	1/8"	92	20	111
3/8"	95,5	6,5	40	1/8"	111,0	24	-
1/2"	128,0	7,5	50	1/8"	142,0	28	-

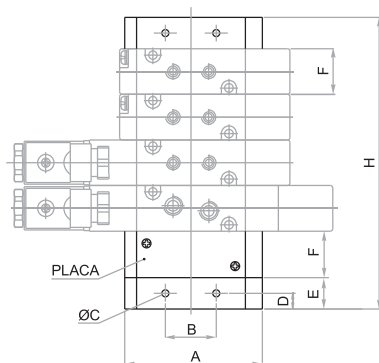
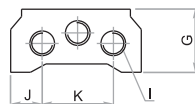

Manifolds

Serie	A	B	C	D	E	F	G
VSM02	61	21	4,5	6	12	22,4	26
VSM03	75	26	4,5	6	13,5	27,3	30
VSN04	104	32	5,5	7	14,5	34,3	38

Serie	2H	3H	4H	5H	6H	7H	8H
VSM02	69	92	115	138	161	184	207
VSM03	82	110	138	166	194	222	250
VSN04	98	133	168	203	238	273	-

Serie	9H	10H	11H	12H	I	J	K
VSM02	230	253	276	299	1/4"	9	43
VSM03	278	306	334	362	3/8"	11	53
VSN04	-	-	-	-	1/2"	18	68

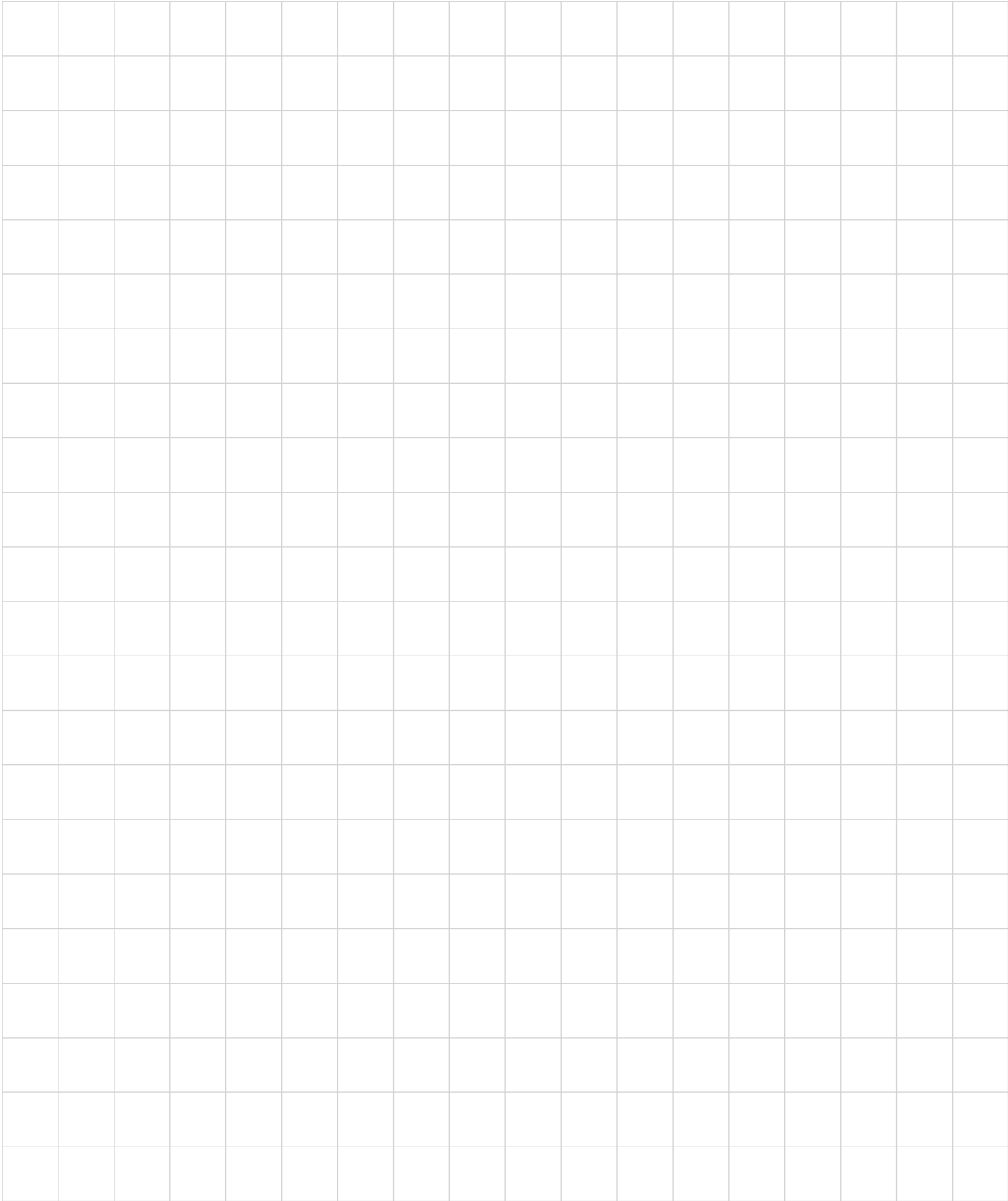

VALVULAS MINIATURA MANUALES Y MECANICAS 3/2

SERIE VMM 1/8 NPT

Art

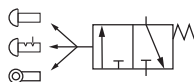

Características

- Diferentes tipos de accionamiento
- Compactas
- Libres de mantenimiento
- Especiales para tablero de control

Datos Técnicos

Fluido:

Aire comprimido Filtrado,
lubricado o no lubricado

Presión de Trabajo:

0 a 10 Bar ~ 0 a 145 PSI

Temperatura de Trabajo:

-20°C a 70°C ~ -4°F a 158°F

Modelos Standard Resorte Resorte

Referencia	NPT	Operador	CV	Color
VMM020112	1/8"	Botón Sobresaliente / Resorte - BS	0.14	Rojo
VMM020113	1/8"	Botón Sobresaliente / Resorte - BS	0.14	Verde
VMM020122	1/8"	Botón Rasante / Resorte - BR	0.14	Rojo
VMM020123	1/8"	Botón Rasante / Resorte - BR	0.14	Verde
VMM020132	1/8"	Botón Hongo / Resorte - B	0.14	Rojo
VMM020133	1/8"	Botón Hongo / Resorte - B	0.14	Verde
VMM020144	1/8"	Rodillo Lateral - R	0.14	Metálico
VMM020154	1/8"	Rodillo Escalizable - RE	0.14	Metálico

Materiales

Cuerpo : Aluminio
Carrete : Aluminio
Sellos : NBR
Operador : Plástico ABS
Rodillo : Acero Niquelado

Modelos Standard Dos Posiciones

Referencia	NPT	Operador	CV	Color
VMM030182	1/8"	Botón / Dos Posiciones - BP	0.14	Rojo
VMM030183	1/8"	Botón / Dos Posiciones - BP	0.14	Verde
VMM030191	1/8"	Codillo / Dos Posiciones - C	0.14	Negro
VMM0301912	1/8"	Parada de Emergencia - PE	0.14	Rojo

Dimensiones de la válvula

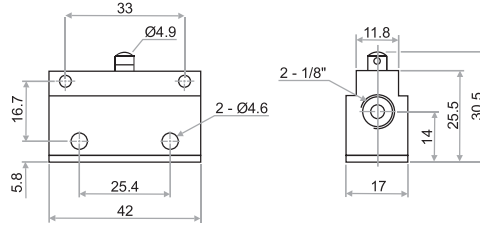

Operadores Regreso Resorte

BS - Botón Sobresaliente

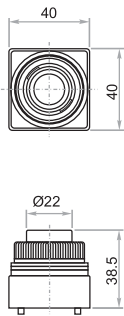

BS - Botón Rasante

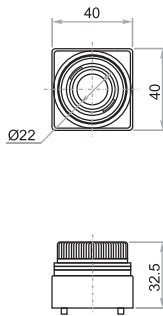

B - Botón Hongo

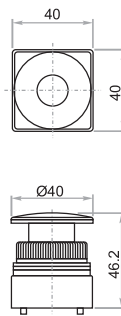

R - Rodillo Lateral

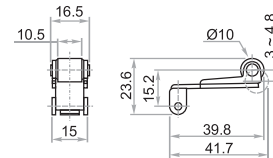

RE - Rodillo Escalizable

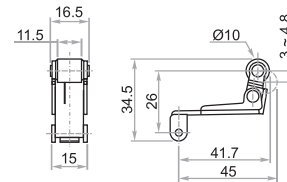

Operadores Dos Posiciones

BP - Botón

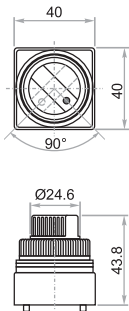

C - Codillo

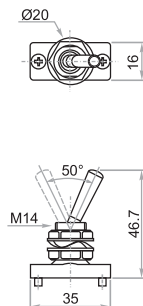

PE - Parada de Emergencia

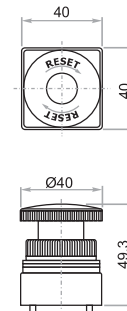

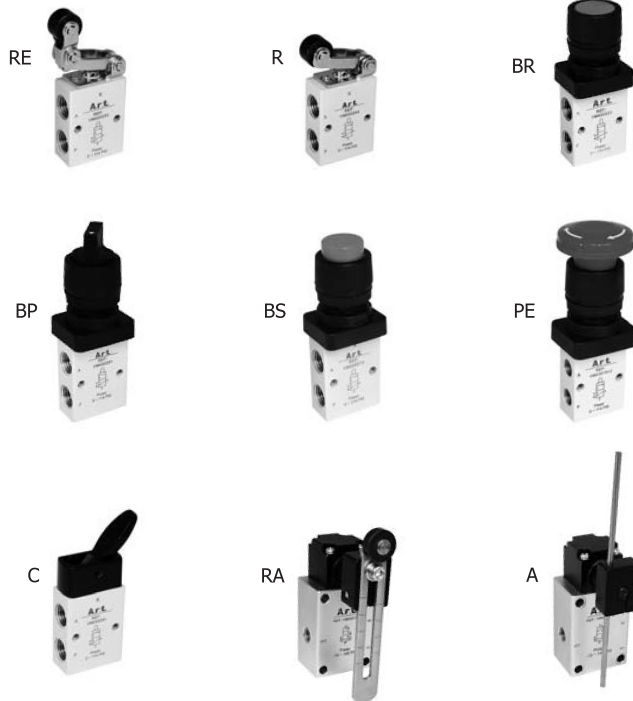
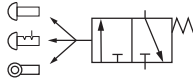

Características

- Diferentes tipos de accionamiento
- Tamaño muy compacto
- Libres de mantenimiento
- Especiales para tablero de control

Datos Técnicos

Fluido:
Aire comprimido Filtrado,
lubricado o no lubricado

Presión de Trabajo:
0 a 8 Bar ~ 0 a 114 PSI

Temperatura de Trabajo:
0°C a 60°C ~ 32°F a 140°F

Modelos Standard Regreso Resorte

Referencia	NPT	Operador	CV	Color
VM020112	1/8"	Botón Sobresaliente / Resorte - BS	0.45	Rojo
VM020113	1/8"	Botón Sobresaliente / Resorte - BS	0.45	Verde
VM020122	1/8"	Botón Rasante / Resorte - BR	0.45	Rojo
VM020123	1/8"	Botón Rasante / Resorte - BR	0.45	Verde
VM020144	1/8"	Rodillo Lateral - R	0.45	Metálico
VM020154	1/8"	Rodillo Escualizable - RE	0.45	Metálico
VM020164	1/8"	Rodillo Ajustable - RA	0.34	Metálico
VM020174	1/8"	Antena - A	0.34	Metálico
VM020212	1/4"	Botón Sobresaliente / Resorte - BS	0.45	Rojo
VM020213	1/4"	Botón Sobresaliente / Resorte - BS	0.45	Verde
VM020222	1/4"	Botón Rasante / Resorte - BR	0.45	Rojo
VM020223	1/4"	Botón Rasante / Resorte - BR	0.45	Verde
VM020244	1/4"	Rodillo Lateral - R	0.45	Metálico
VM020254	1/4"	Rodillo Escualizable - RE	0.45	Metálico

Modelos Standard Dos Posiciones

Referencia	NPT	Operador	CV	Color
VM030181	1/8"	Botón / Dos Posiciones - BP	0.45	Negro
VM030191	1/8"	Codillo / Dos Posiciones - C	0.45	Negro
VM030192	1/8"	Parada de Emergencia - PE	0.45	Rojo
VM030281	1/4"	Botón / Dos Posiciones - BP	0.45	Negro
VM030291	1/4"	Codillo / Dos Posiciones - C	0.45	Negro
VM030292	1/4"	Parada de Emergencia - PE	0.45	Rojo

Materiales

Cuerpo : Aluminio
 Carrete : Aluminio
 Sellos : NBR
 Operador : Plástico ABS
 Rodillo : Acero Niquelado

Dimensiones de la válvula

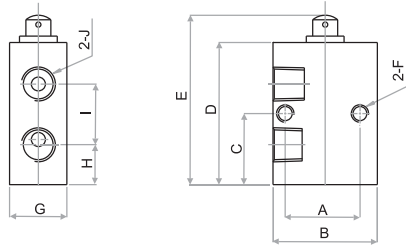

NPT	A	B	C	D	E
1/8"	23	30	20,5	41	47
1/4"	24	34	22,5	46	52

NPT	F	G	H	I	J
1/8"	M5x0,8	16,5	11,5	17,5	1/8"
1/4"	M5x0,8	17,5	12	21	1/4"

Operadores Regreso Resorte

BS - Botón Sobresaliente

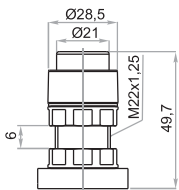
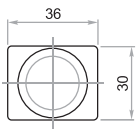

BS - Botón Rasante

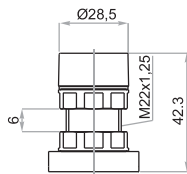
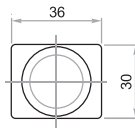

R - Rodillo Lateral

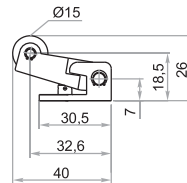
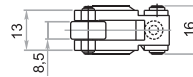

R - Rodillo Escalizable

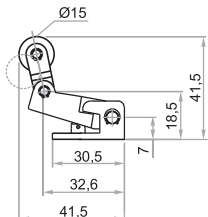
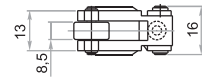

Operadores Dos Posiciones

BP - Botón

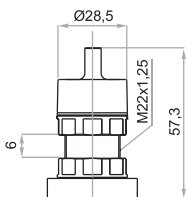
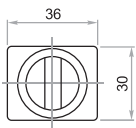

C - Codillo

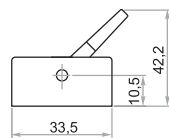
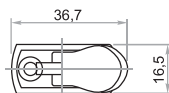

PE - Parada de Emergencia

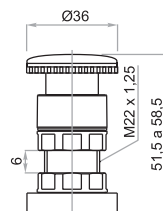
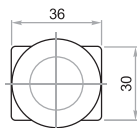

Válvulas de Rodillo Ajustable y Antena

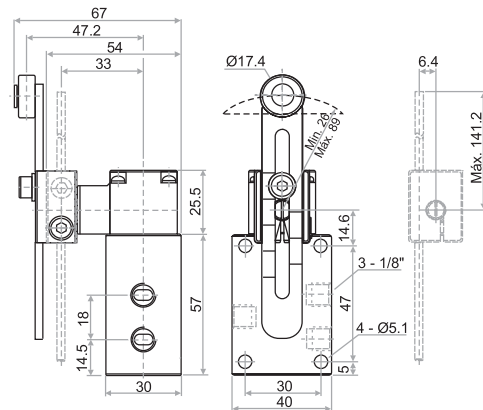

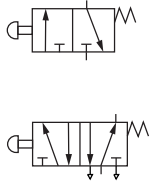

Tope - Resorte



Codillo

Características

- Válvulas muy compactas
- Resistentes a la corrosión
- Versiones con operador de botón ó codillo, y operadores adicionales externos de piloto de aire y rodillos
- Ideales para manejar cilindros de pequeñas dimensiones o como elementos de control

Válvulas Miniatura 3/2

Referencia	NPT	Operador	SCFM
VMC02011	1/8"	Tope - Resorte	18
VMC03019	1/8"	Codillo / Dos Posiciones	18

Válvulas Miniatura 5/2

Referencia	NPT	Operador	SCFM
VMC08011	1/8"	Tope - Resorte	18
VMC09019	1/8"	Codillo / Dos Posiciones	18

Datos Técnicos

Fluido:
 Aire comprimido Filtrado y lubricado

Presión de Trabajo:
 0 a 9 Bar ~ 0 a 130 PSI

Temperatura de Trabajo:
 -10°C a 60°C ~ 14°F a 140°F

Operadores

Operador de Aire	Rodillo	Rodillo Escualizable
------------------	---------	----------------------



Materiales

- Cuerpo : Aluminio
 Operador : Acero Inoxidable
 Operador Externo : Bronce
 Sellos : Buna N

Referencia	Referencia	Referencia
VMC0	VMC4	VMC5

3/2 Tope - Resorte

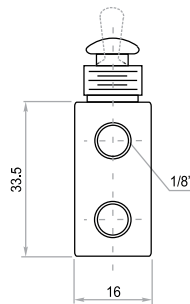
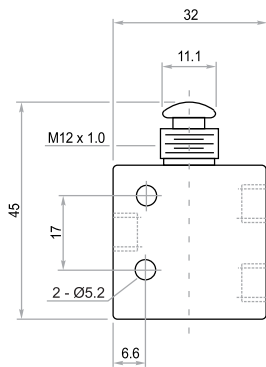

3/2 Codillo

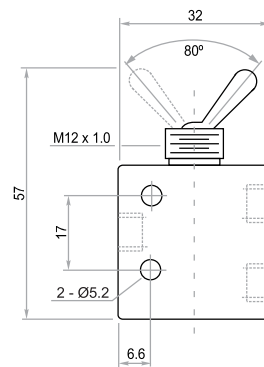

5/2 Tope - Resorte

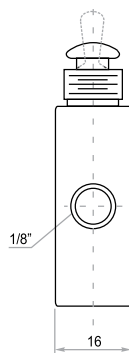
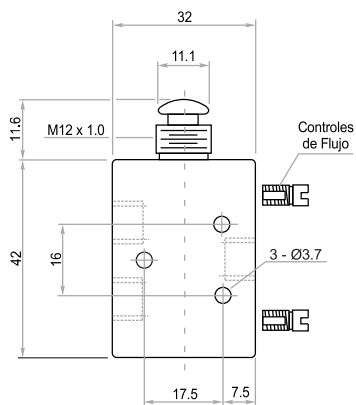

5/2 Codillo

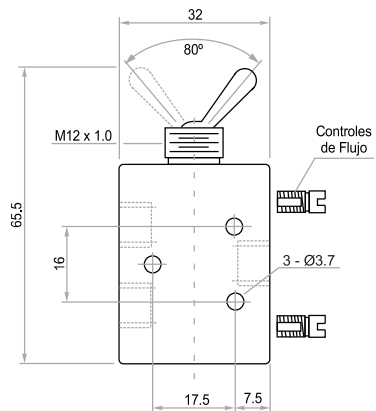

VALVULAS DE BOTON 3/2 - 5/2

SERIE VB 1/4 - 3/8 NPT

Art

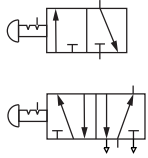

3/2



5/2



Características

- Normalmente cerradas
- Dos posiciones fijas
- Tamaño muy compacto
- Resistentes a la corrosión
- Montaje en tablero

Datos Técnicos

Fluido:

Aire comprimido Filtrado,
lubricado o no lubricado

Presión de Trabajo:

0 a 8 Bar ~ 0 a 114 PSI

Temperatura de Trabajo:

-20°C a 70°C ~ -4°F a 158°F

Válvulas de Botón 3/2 Vías

Referencia	NPT	Operador	Cv
VB0302	1/4"	Botón / 2 Posiciones	0,89
VB0303	3/8"	Botón / 2 Posiciones	1,67

Materiales

Cuerpo : Aluminio
Sellos : NBR

Válvulas de Botón 5/2 Vías

Referencia	NPT	Operador	Cv
VB0902	1/4"	Botón / 2 Posiciones	0,89
VB0903	3/8"	Botón / 2 Posiciones	1,67

Válvulas 3/2

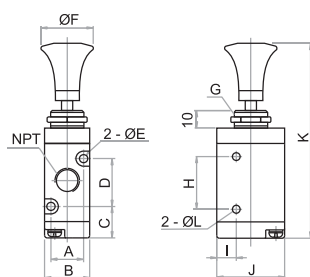

Válvulas 5/2

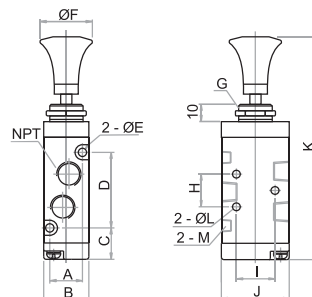

NPT	Válvulas 3/2		Válvulas 5/2	
	1/4"	3/8"	1/4"	3/8"
A	17	20	17	20
B	22	27	22	27
C	12,7	15	12,7	15
D	30	35	38	50
E	3,3	4,3	3,3	4,3
F	22	25	22	25
G	M14x1,0	M16x1,0	M14x1,0	M16x1,0
H	25	30	20	24
I	8	10	23,5	27,5
J	35	40	35	40
K	90	100	98	115
L	4,3	4,3	4,3	4,3
M	-	-	1/8"	1/4"

VPP



VP



VP-G

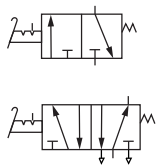

Válvulas de Pedal 3/2 Vías

Referencia	NPT	Operador
VPP0202	1/4"	Pedal / Resorte (Pedal Plástico)
VP0202	1/4"	Pedal / Resorte

Válvulas de Pedal 5/2 Vías

Referencia	NPT	Operador
VP0802	1/4"	Pedal / Resorte
VP0802G	1/4"	Pedal / Resorte / Protector
VP0902	1/4"	Pedal / Dos Posiciones
VP0902G	1/4"	Pedal / 2 posiciones / Protector

Características

- 3/2 Normalmente cerradas
- Regreso por resorte ó dos posiciones fijas
- Protector plástico que previene golpes y operaciones involuntarias

Datos Técnicos

Fluido:
 Aire comprimido Filtrado,
 lubricado o no lubricado

Presión de Trabajo:
 0 a 8 Bar ~ 0 a 114 PSI

Temperatura de Trabajo:
 -5°C a 60°C ~ 23°F a 140°F

Válvulas 3/2
 Cuerpo Plástico

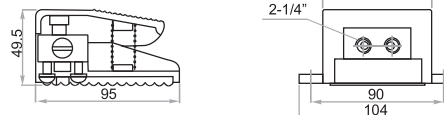

Válvulas 3/2
 Cuerpo Metálico

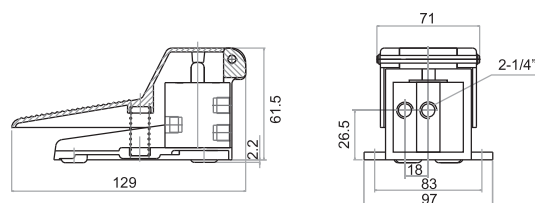

Válvulas 5/2
 Cuerpo Metálico

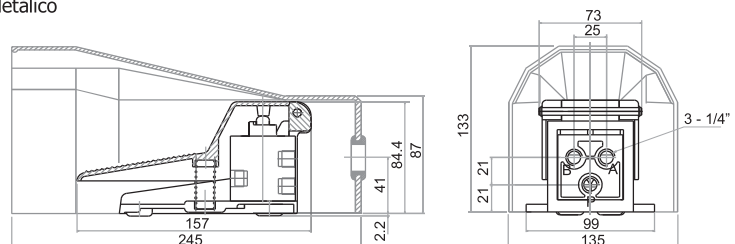

Materiales

- Cuerpo VPP : Plástico
- Cuerpo VP : Aluminio
- Carrete : Aluminio
- Sellos : NBR

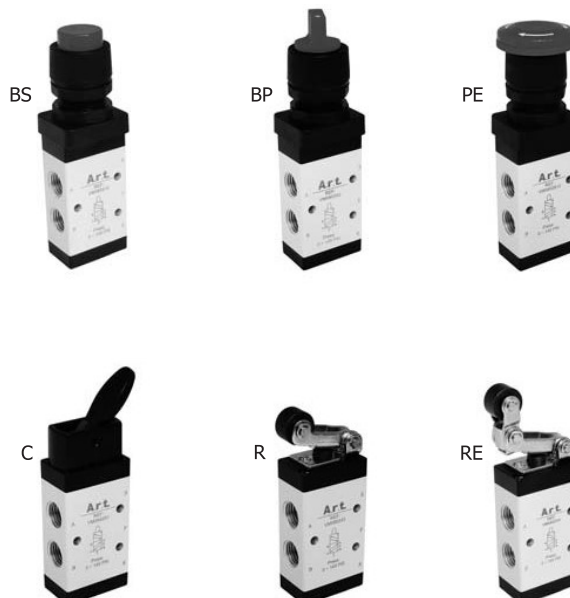
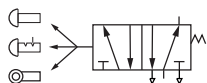

Características

- Diferentes tipos de accionamiento
- Compactas
- Libres de mantenimiento
- Especiales para tablero de control

Datos Técnicos

Fluido:
Aire comprimido Filtrado,
lubricado o no lubricado

Presión de Trabajo:
0 a 10 Bar ~ 0 a 145 PSI

Temperatura de Trabajo:
-20°C a 70°C ~ -4°F a 158°F

Modelos Standard Regreso Resorte

Referencia	NPT	Operador	CV	Color
VM080212	1/4"	Botón Sobresaliente / Resorte - BS	0.67	Rojo
VM080213	1/4"	Botón Sobresaliente / Resorte - BS	0.67	Verde
VM080243	1/4"	Rodillo Lateral - R	0.67	Metálico
VM080254	1/4"	Rodillo Escualizable - RE	0.67	Metálico

Materiales

Cuerpo : Aluminio
Carrete : Aluminio
Sellos : NBR
Operador : Plástico ABS
Rodillo : Acero Niquelado

Modelos Standard Dos Posiciones

Referencia	NPT	Operador	CV	Color
VM090282	1/4"	Botón / Dos Posiciones - BP	0.67	Rojo
VM090283	1/4"	Botón / Dos Posiciones - BP	0.67	Verde
VM090291	1/4"	Codillo / Dos Posiciones - C	0.67	Negro
VM0902912	1/4"	Parada de Emergencia - PE	0.67	Rojo

Dimensiones de la válvula

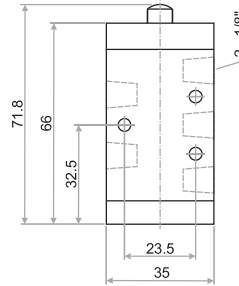
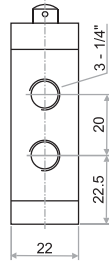

Operadores Regreso Resorte

BS - Botón Sobresaliente

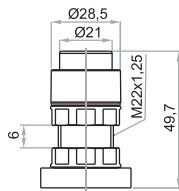
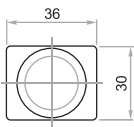

R - Rodillo Lateral

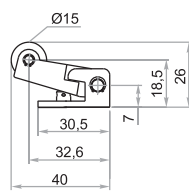
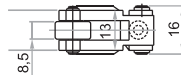

R - Rodillo Escalizable

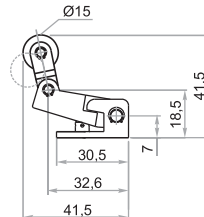
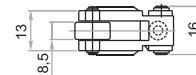

Operadores Dos Posiciones

BP - Botón

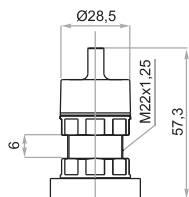
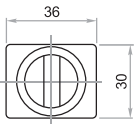

C - Codillo

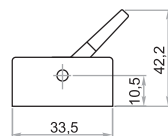
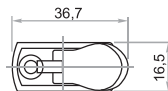

PE - Parada de Emergencia

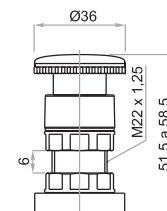
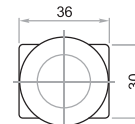

VALVULAS DE PALANCA 5/2 - 5/3

SERIE VPA 1/8 - 1/4 - 3/8 NPT

Art

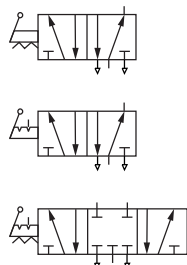

Características

- Dos y tres posiciones
- Tamaño muy compacto
- Montaje en panel
- Resistentes a la corrosión
- Alta capacidad de flujo

Válvulas de Palanca 5/2 Vías

Referencia	NPT	Operador	Cv
VPA0802	1/4"	Palanca / Resorte	0,89
VPA0803	3/8"	Palanca / Resorte	1,67
VPA0901	1/8"	Palanca / 2 Posiciones Fijas	0,78
VPA0902	1/4"	Palanca / 2 Posiciones Fijas	0,89
VPA0903	3/8"	Palanca / 2 Posiciones Fijas	1,67

Válvulas de Palanca 5/3 Vías - Centros Cerrados

Referencia	NPT	Operador	Cv
VPA1002	1/4"	Palanca / 3 Posiciones / Resorte	0,67
VPA1003	3/8"	Palanca / 3 Posiciones / Resorte	1,00

Datos Técnicos

Fluido:

Aire comprimido Filtrado, lubricado o no lubricado

Presión de Trabajo:

0 a 8 Bar ~ 0 a 114 PSI

Temperatura de Trabajo:

-20°C a 70°C ~ -4°F a 158°F

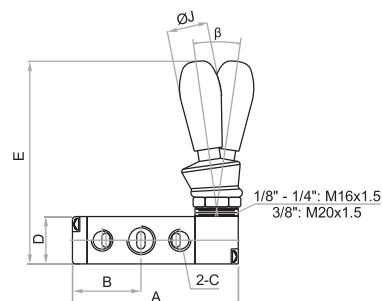
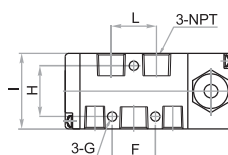

NPT	A	B	C	D	E	F
1/8"	81,5	32,5	1/8"	22	90	20
1/4"	81,5	32,5	1/8"	22	90	20
3/8"	101	40,5	1/4"	27	93,5	24
1/4" (5/3)	100,5	32,5	1/8"	22	90,5	20
3/8" (5/3)	120	40,5	1/4"	27	94	24

NPT	ØG	H	I	ØJ	β	L
1/8"	4,3	23,5	35	18	15	18
1/4"	4,3	23,5	35	18	15	21
3/8"	4,3	27,5	40	18	18	24
1/4" (5/3)	4,3	23,5	35	18	8,5	21
3/8" (5/3)	4,3	27,5	40	18	10	24

Materiales

Cuerpo : Aluminio
 Sellos : NBR
 Palanca : Nylon

VALVULAS ROTATIVAS 4/2 - 4/3

SERIE VR 1/4 - 3/8 - 1/2 NPT

Art

VALVULAS

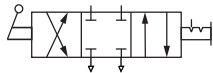

Características

- Centros cerrados
- Permiten 2 ó 3 posiciones
- Operador manual por giro de la palanca
- Un escape común
- Montaje en tablero

Montaje en Panel

Referencia	NPT	Operador	Cv
VR0502	1/4"	Palanca Rotativa 2 posiciones	0,89
VR0503	3/8"	Palanca Rotativa 2 posiciones	1,83
VR0504	1/2"	Palanca Rotativa 2 posiciones	4,89
VR0702	1/4"	Palanca Rotativa 2 ó 3 posiciones	0,89
VR0703	3/8"	Palanca Rotativa 2 ó 3 posiciones	1,83
VR0704	1/2"	Palanca Rotativa 2 ó 3 posiciones	4,89

Datos Técnicos

Fluido:

Aire comprimido Filtrado,
lubricado o no lubricado

Presión de Trabajo:

0 a 10 Bar ~ 0 a 142 PSI

Temperatura de Trabajo:

-20°C a 70°C ~ -4°F a 158°F

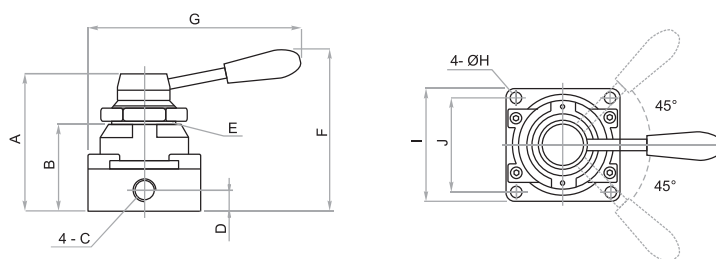

Materiales

Cuerpo : Aluminio
Disco : Aluminio
Sellos : NBR

NPT	A	B	C	D	E	F	G	H	I	J
1/4"	72,6	45	1/4"	11,5	M34x1,5	92,5	120	5,5	62	49
3/8"	88,5	56	3/8"	13,5	M40x1,5	104	140	6,6	74	62
1/2"	110,3	72	1/2"	18	M52x1,5	128	160	6,6	102	89

Art

Válvulas-109